

ANJUARGO, S.L.

100 TACO ESTRIADO

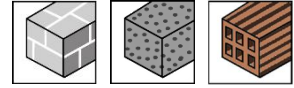

ESTRIADO



PEBD
POLIETILENO

Código	Referencia	CtaxBolsa	CtaxEnvase	€/100
100B05	Ø 5x20 mm	25	30000	1,07
100B06	Ø 6x22 mm	25	25000	1,38
100B07	Ø 7x23 mm	25	18000	1,50
100B08	Ø 8x25 mm	25	15000	1,85
100B09	Ø 9x30 mm	25	10000	2,25
100B10	Ø 10x40 mm	25	8000	3,58
100B11	Ø 10x50 mm	25	5000	4,34
100B12	Ø 12x50 mm	25	5000	5,80
100B14	Ø 14x50 mm	25	3000	7,70

Granel



Código	Referencia	CtaxEnvase	€/100
100G05	Ø 5x20 mm	50000	0,94
100G06	Ø 6x22 mm	30000	1,20
100G07	Ø 7x23 mm	30000	1,38
100G08	Ø 8x25 mm	20000	1,70
100G09	Ø 9x30 mm	15000	2,10
100G10	Ø 10x40 mm	15000	3,15
100G11	Ø 10x50 mm	10000	3,95
100G12	Ø 12x50 mm	8000	5,60
100G14	Ø 14x50 mm	4000	7,40

TACO MANPOSTERIA



PEBD
POLIETILENO

Código	Referencia	CtaxBolsa	CtaxEnvase	€/100
TE1025	Ø 10X25 mm	50	12000	3,40

Características Técnica Estriados*

Código	Referencia	Tornillo a utilizar	Extraccion Kg. Ladri.Hueco
100G05	Ø 5x20 mm	3x30	26
100G06	Ø 6x22 mm	3.5x30	27
100G07	Ø 7x23 mm	4.0x30	31
100G08	Ø 8x25 mm	4.0x30	50
100G09	Ø 9x30 mm	4,5x35	37
100G10	Ø 10x40 mm	4,5x45	46
100G11	Ø 10x50 mm	4,5x55	46
100G12	Ø 12x50 mm	5x60	55
100G14	Ø 14x50 mm	5x60	59

*Según normativa ISO 5893

ANJUARGO, S.L.

101 TACO FIXON

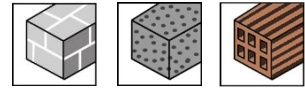

Ny
NYLÓN



Código	Referencia	Tornillo a Utilizar	CtaxCaja	CtaxEnvase	€/100
101C04	Ø 4x20 mm	2.0 a 3.0	200	4000	2,10
101C05	Ø 5x25 mm	2.5 a 4.0	200	4000	1,30
101C06	Ø 6x30 mm	3.5 a 4.0	200	10000	1,48
101C07	Ø 7x30 mm	4.0 a 4.5	100	5000	2,50
101C08	Ø 8x40 mm	4.5 a 6.0	100	5000	2,88
101C10	Ø 10x50 mm	6.0 a 8.0	50	2500	4,85
101C12	Ø 12x60 mm	8.0 a 10.0	25	1250	8,45
101C14	Ø 14x75 mm	10.0 a 12.0	25	1250	13,60

Granel



Código	Referencia	CtaxCaja	€/100
101G04	Ø 4x20 mm	30000	1,20
101G05	Ø 5x25 mm	70000	1,10
101G06	Ø 6x30 mm	40000	1,18
101G07	Ø 7x30 mm	35000	2.18
101G08	Ø 8x40 mm	15000	2,48
101G10	Ø 10x50 mm	8000	4,25
101G12	Ø 12x60 mm	5000	6,85
101G14	Ø 14x75 mm	3000	12,30

Blíster



Código	Referencia	Uds x Bl.	Bl x Caja	€ x Blíster
94397	Ø 4x20	20	15	1
94344	Ø 5x25	15	15	1
94345	Ø 6x30	10	15	1
94346	Ø 8x40	6	15	1
94347	Ø 10x50	4	15	1
94396	Ø 12x60	4	15	1

FIXON CON TORNILLO POZIDRIV

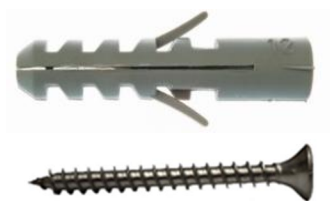

Blíster



Código	Referencia	Uds x Bl	Bl x Caja	€ x Blíster
94398	Ø 4 + TP 3x20	20	15	1.2
94348	Ø 5 + TP 3,5x40	15	15	1,2
94349	Ø 6 + TP 4,5x40	10	15	1,2
94350	Ø 8 + TP 5,0x50	4	15	1,2
94351	Ø 8 + TP 6x60	4	15	1.2

Bolsa Autoservicio



Código	Referencia	Uds x Bl	Bl x Caja	€ x Bolsa
TNF05P3540-B025	Ø 5 + TP 3,5x40	25	30	1,6
TNF06P4540-B025	Ø 6 + TP 4,5x40	25	25	2.0
TNF08P5050-B025	Ø 8 + TP 5,0x50	25	20	2.2
TNF08P6060-B025	Ø 8 + TP 6x60	25	15	2.3

ANJUARGO, S.L.

101 FIXON CON COLLARIN

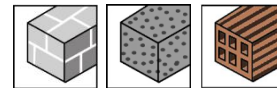

Código	Referencia	Tornillo a Utilizar	CtaxCaja	CtaxEnvase	€/100
101CC05	Ø 5x25 mm	2.5 a 4.0	200	4000	1,30
101CC06	Ø 6x30 mm	3.5 a 4.0	200	4000	1,50
101CC08	Ø 8x40 mm	4.0 a 4.5	100	2000	2,90
101CC10	Ø 10x50 mm	4.5 a 6.0	50	1000	5,80
101CC12	Ø 12x60 mm	8.0 a 10.0	25	500	10,90

Granel

Código	Referencia	CtaxCaja	€/100
101CG05	Ø 5x25 mm	60000	1,10
101CG06	Ø 6x30 mm	35000	1,20
101CG08	Ø 8x40 mm	15000	2,50
101CG10	Ø 10x50 mm	8000	5,05
101CG12	Ø 12x60 mm	4500	10,00

Características Técnica Fixon

Código	Referencia	Tornillo a Utilizar	Extraccion Kg .Hormigon	Extraccion Kg. Ladri. Macizo	Extraccion Kg. Ladri.Hueco
101C04	Ø4X20 mm	2.5-3	28	20	15
101C05	Ø 5x25 mm	3.5-4x30	42	36	24
101C06	Ø 6x30 mm	4-4.5x40	64	50	24
101C07	Ø7X30 mm	4.5X40	76	64	24
101C08	Ø 8x40 mm	4.5-5x50	90	80	24
101C10	Ø 10x50 mm	5-6x60	180	88	40
101C12	Ø 12x60 mm	8X80	210	90	44
101C14	Ø 14x70 mm	10x95	390	96	48

ANJUARGO, S.L.

105 TACO N+PLUS

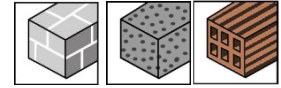

Ny
NYLON

Código	Referencia	Tornillo a Utilizar	CtaxCaja	CtaxEnvase	€/100
105C05	Ø 5x25 mm	4x30	200	4000	2,24
105C06	Ø 6x30 mm	4.5x30	200	10000	2,24
105C08	Ø 8x40 mm	5x50	100	5000	4,40
105C10	Ø 10x50 mm	6x60	50	2500	8,30
105C12	Ø 12x60 mm	10x70/12x70	25	1250	18,00
105C14	Ø 14x70 mm	10x80/12x80	20	400	23,00



Granel

Código	Referencia	CtaxCaja	€/100
105G06	Ø 6x30 mm	40000	2,10
105G08	Ø 8x40 mm	15000	3,60
105G10	Ø 10x50 mm	8000	6,40

Blíster



Código	Descripción	Uds x Bl.	Bl. x caja	€ x Blíster
926317	Ø 5x25	20	15	1
010511	Ø 6x30	20	15	1
010528	Ø 8x40	10	15	1
010535	Ø 10x50	4	15	1
010541	Ø 12x60	4	15	1

Características Técnica N+PLUS

Código	Referencia	Tornillo a Utilizar	Extraccion Kg .Hormigon	Extraccion Kg. Ladri. Macizo	Extraccion Kg. Ladri.Hueco
105C05	Ø 5x25 mm	4x30	80	46	18
105C06	Ø 6x30 mm	4.5x30	110	90	20
105C08	Ø 8x40 mm	5x50	120	100	40
105C10	Ø 10x50 mm	6x60	186	110	60
105C12	Ø 12x60 mm	10x70/12x70	260	120	80
105C14	Ø 14x70 mm	10x80/12x80	400	130	90

105 TACO ECOPLUS



PP
POLIPROPILENO

Código	Referencia	Tornillo a Utilizar	CtaxCaja	CtaxEnvase	€/100
105AC06	Ø 6x30 mm	4.5x30	200	10000	1,75
105AC08	Ø 8x40 mm	5x50	100	5000	3,00

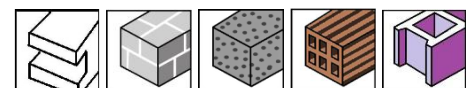

117 TACO DE NUDO NZK

MULTIMATERIAL



Ny
NYLON

Código	Referencia	Tornillo a Utilizar	CtaxCaja	CtaxEnvase	€/100
117063	Ø 6x30 mm	4.5x30	200	10000	2,80
117064	Ø 6x40 mm	4.5x40	100	5000	3,10
117080	Ø 8x50 mm	5x50	50	2500	5,80
117010	Ø 10x60 mm	6x60	40	2000	11,40

ANJUARGO, S.L.

118 TACO ARPON NFN

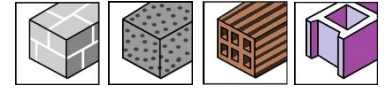

Código	Referencia	Tornillo a Utilizar	CtaxCaja	CtaxEnvase	€/100
118C06	Ø 6x40 mm	4.5x40	50	2500	3,40
118C08	Ø 8x50 mm	5x50	50	2500	6,70
118C10	Ø 10x60 mm	6x60	50	2500	10,60

Hasta final de existencias

106 TACO CLAVABLE



Z

Zinc

Código	Referencia	CtaxCaja	CtaxEnvase	€/100
106A05030	Ø 5x30 mm	100	2000	5,15
106A05040	Ø 5x40 mm	100	2000	7,00
106A05050	Ø 5x50 mm	100	2000	7,60
106A06040	Ø 6x40 mm	100	2000	6,30
106A06050	Ø 6x50 mm	50	1000	7,40
106A06060	Ø 6x60 mm	50	1000	8,95
106A06080	Ø 6x80 mm	50	1000	11,90
106A08045	Ø 8x45 mm	50	1000	11,50
106A08060	Ø 8x60 mm	50	1000	15,00
106A08080	Ø 8x80 mm	50	450	19,30
106A08100	Ø 8x100 mm	50	450	25,00
106A08120	Ø 8x120 mm	50	450	27,00

Características Técnica clavable

Código	Medidas	Extraccion Kg .Hormigon	Extraccion Kg. Ladri. Macizo
106A	Ø 5 mm	33	22
106A	Ø 6 mm	37	30
106A	Ø 8 mm	45	36

Blíster

Código	Referencia	Uds x Bl.	Bl. x caja	€ x Blister
11435	Ø 5x30	10	15	1,2
11436	Ø 5x40	10	15	1,2
11437	Ø 5x50	10	15	1,2
11438	Ø 6x40	10	15	1,2
11439	Ø 6x50	10	15	1,2
11440	Ø 6x60	10	15	1,2
11442	Ø 6x80	10	15	1,2
11443	Ø 8x45	10	15	1,2
11444	Ø 8x60	5	15	1,2

Bolsa Autoservicio

Código	Referencia	Uds x Bl.	Bl. x caja	€ x Bolsa
TG05030-B025	Ø 5x30	25	25	1,25
TG05040-B025	Ø 5X40	25	25	1,70
TG05050-B025	Ø 5X50	25	25	1,85
TG06040-B025	Ø 6x40	25	20	1,55
TG06060-B025	Ø 6x60	25	15	2,19
TG06080-B025	Ø 6x80	25	15	2,92
TG08060-B025	Ø 8x60	25	20	3,70
TG08080-B010	Ø 8X80	10	15	1,91
TG08100-B010	Ø 8X100	10	15	2,48
TG08120-B010	Ø8X120	10	15	2,68

ANJUARGO, S.L.

108 TACO UNIVERSAL

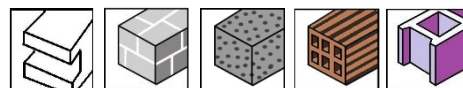

ALCAYATA LARGA



Z
Zinc

Ny
NYLON

Código	Referencia	Udsxcaja	€/100
108EL09	Ø 9 mm	100	40.20
108EL12	Ø 12 mm	100	53.40

Blíster

Código	Referencia	Uds x Bl.	Bl. x caja	€ x Blister
11458	Ø 9 mm	2	15	1,9
11460	Ø 12 mm	2	15	1,9

ALCAYATA CORTA



Z
Zinc

Ny
NYLON

Código	Referencia	Udsxcaja	€/100
108EC09	Ø 9 mm	100	40.20
108EC12	Ø 12 mm	100	53.40

Blíster

Código	Referencia	Uds x Bl.	Bl. x caja	€ x Blister
11454	Ø 9 mm	2	15	1,9
11456	Ø 12 mm	2	15	1,9

GANCHO



Z
Zinc

Ny
NYLON

Código	Referencia	Udsxcaja	€/100
108G09	Ø 9 mm	100	46.20
108G12	Ø 12 mm	100	61.80

Blíster

Código	Referencia	Uds x Bl.	Bl. x caja	€ x Blister
11462	Ø 9 mm	2	15	1,9
11464	Ø 12 mm	1	15	1,9

TORNILLO

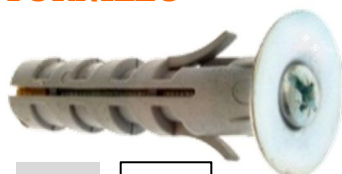

Z
Zinc

Ny
NYLON

Código	Referencia	Udsxcaja	€/100
108T09	Ø 9 mm	100	35.40
108T12	Ø 12 mm	100	49.50

Blíster

Código	Referencia	Uds x Bl.	Bl. x caja	€ x Blister
11450	Ø 9 mm	2	15	1,9
11452	Ø 12 mm	2	15	1,9

ARGOLLA



Z
Zinc

Ny
NYLON

Código	Referencia	Udsxcaja	€/100
108A09	Ø 9 mm	100	47.40
108A12	Ø 12 mm	100	63.60

Blíster

Código	Referencia	Uds x Bl.	Bl. x caja	€ x Blister
11466	Ø 9 mm	2	15	1,9
11468	Ø 12 mm	1	15	1,9

ANJUARGO, S.L.

107 FIJACIONES LARGAS

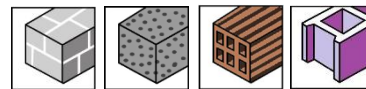

TACO FACHADA



Código	Referencia	Espesor a Fijar	CtaxCaja	CtaxEnvase	€/100
107S08060	Ø 8x60 mm	20	50	1000	9,80
107S08080	Ø 8x80 mm	40	40	800	11,60
107S08100	Ø 8x100 mm	60	100	900	9,30
107S08120	Ø 8x120 mm	80	50	450	11,70
107S10080	Ø 10x80 mm	15	50	450	13,30
107S10100	Ø 10x100 mm	25	50	450	15,60
107S10115	Ø 10x115 mm	40	50	450	16,60
107S10135	Ø 10x135 mm	60	50	450	18,10
107S10160	Ø 10x160 mm	85	50	450	23,05

TACO FACHADA + TORX CABEZA AVELLANADA



Código	Referencia	Huella	Espesor a Fijar	CtaxCaja	€/100
107T08080	Ø 8x80 mm	Tx-30	15	50	40,00
107T08100	Ø 8x100 mm	Tx-30	35	50	45,00
107T08120	Ø 8x120 mm	Tx-30	55	50	55,00
107T10080	Ø 10x80 mm	Tx-40	15	50	45,00
107T10100	Ø 10x100 mm	Tx-40	25	50	57,00
107T10115	Ø 10x120 mm	Tx-40	40	50	66,00
107T10140	Ø 10x135 mm	Tx-40	60	50	81,00
107T10160	Ø 10x160 mm	Tx-40	85	50	101,00

Característica Técnica Fachada

Código	Referencia	Tornillo Torx	Extraccion Kg Hormigon	Cizalladura Kg Hormigon	Extraccion Kg. Ladri. Macizo	Extraccion Kg. Ladri.Hueco
107T08080	Ø 8x80 mm	Ø 5.5 mm	80	130	65	50
107T08100	Ø 8x100 mm	Ø 5.5 mm	80	130	65	50
107T08120	Ø 8x120 mm	Ø 5.5 mm	80	130	65	50
107T10080	Ø 10x80 mm	Ø 7.0 mm	120	200	80	75
107T10100	Ø 10x100 mm	Ø 7.0 mm	120	200	80	75
107T10115	Ø 10x120 mm	Ø 7.0 mm	120	200	80	75
107T10140	Ø 10x135 mm	Ø 7.0 mm	120	200	80	75
107T10160	Ø 10x160 mm	Ø 7.0 mm	120	200	80	75

ANJUARGO, S.L.

107 FIJACIONES LARGAS **HOMOLOGADO**



ETAG 12-0261

TACO FGX SUELTO



Código	Referencia	CtaxCaja	€/100
107XS08080	Ø 8x80 mm	100	22,50
107XS08100	Ø 8x100 mm	100	23,65
107XS08120	Ø 8X120 mm	50	32,76
107XS08140	Ø 8X140 mm	50	35,82
107XS10080	Ø10X80 mm	50	34,80
107XS10100	Ø 10x100 mm	50	39,30
107XS10120	Ø 10x120 mm	50	42,00
107XS10140	Ø 10x140mm	50	44,10
107XS10160	Ø 10X160mm	50	47,10

TACO FGX TORX-40 CABEZA HEXAGONAL



T-40

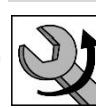

13mm



Código	Referencia	CtaxCaja	€/100
107HT10080	Ø 10x80 mm + Tor.Hex-Torx 40	25	90,00
107HT10100	Ø 10x100 mm + Tor.Hex-Torx 40	25	100,00
107HT10120	Ø 10x120mm + Tor.Hex-Torx 40	25	115,00
107HT10140S	Ø 10X140mm + Tor Hex-Torx 40	50	138,00
107HT10160S	Ø 10x160mm + Tor Hex-Torx 40	50	168,00

Código	Referencia	UdsxBl.	Blxcaja	€/Blister
107HT1080B2	Ø 10x80 mm + Tor.Hex-Torx 40	2	10	2,4
107HT10110B2	Ø 10x100 mm + Tor.Hex-Torx 40	2	10	2,4
107HT10120B2	Ø 10x120mm + Tor.Hex-Torx 40	2	10	2,4

TACO FGX TORX-40 CABEZA AVELLANADA



Código	Referencia	CtaxCaja	€/100
107TX08080	Ø 8x80 mm + Torx 30	50	54,60
107TX08100	Ø 8x100 mm + Torx 30	50	62,80
107TX08120	Ø 8X120 mm + Torx 30	50	71,50
107TX10080	Ø10X80 mm + Torx 40	50	69,60
107TX10100	Ø 10x100 mm + Torx 40	25	80,60
107TX10120	Ø 10x120 mm + Torx 40	25	85,30
107TX10140	Ø 10x140mm + Torx 40	25	108,80
107TX10160	Ø 10X160mm + Torx 40	25	125,10

Característica Técnica

Código	Referencia	Tornillo a Utilizar	Extraccion Kg Hormigon c16/20	Cizalladura Kg Hormigon c16/20	Extraccion Kg. Ladri.Hueco
107TX08	Ø 8mm + Torx 30	Ø 5.5mm	110	200	60
107TX10	Ø 10 mm + Torx 40	Ø 7.0 mm	170	300	80
107HT10	Ø 10 mm + Torx 40	Ø 7.0 mm	170	300	80

ANJUARGO, S.L

211 FIJACIONES PARA ANDAMIO

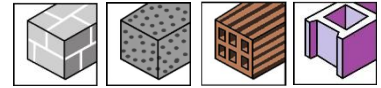

TACO ANDAMIO



Ny
NYLON

Código	Referencia	CtaxCaja	€/100
211T14100	Ø 14 x 100 mm	50	20,00
211T14130	Ø 14 x 130 mm	50	40,00

ARGOLLA PARA ANDAMIO



Z
Zinc

Código	Referencia	CtaxCaja	€/100
211A12120	Ø 12 x 120 mm	25	230,00

313 FIJACIONES PARA SANITARIO

Ny
NYLON

B
Bicro



WC 5X75



WC 8X100
WC 10X110



WC Góndola Horizontal

Código	Referencia	Uds x Bolsa	Bl x Caja	€/Uds
31305075	WC M-5x75	2	50	1,06
31308100	WC/ M-8x100	2	50	1,62
31310110	WC/M-10x110	2	50	2,26
313G	WC/ Góndola	2	50	2,34

Blíster



Código	Referencia	Uds x Bl.	Bl x Caja	€ x Blíster
313575B2	WC M-5x75	2	10	2,7
3138400B2	WC/ M-8x100	2	10	2,7
31310110B2	WC/M-10x110	2	10	4,3
313GONB2	WC/ Góndola	2	10	4,3



ANJUARGO, S.L.

108 FIJACIONES PARA BALDAS

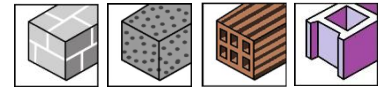

FXO TACO OCULTO



Código	Referencia	Espesor Tablero	CtaxCaja	€x100
108FXO10080	Ø 8X70 M-6	30	25	192
108FXO10100	Ø 10x100 M-8	40	25	256
108FXO10150	Ø 10x150 M-8	40	25	280
108FXO12100	Ø 12x120 M-10	50	25	352



Blíster

Código	Referencia	UdsxBl	CtaxCaja	€x100
108FXO08070B2	Ø 8X70 M-6	2	10	6
108FXO10100B2	Ø 10x100 M-8	2	10	6
108FXO10150B2	Ø 10x150 M-8	2	10	6
108FXO12100B2	Ø 12x100 M-10	2	10	6
108FXO12120B2	Ø 12x120 M-10	2	10	6

109 FIJACIONES PARA PLADUR



TPN TACO PLADUR SIN PUNTA



Código	Referencia	CtaxCaja	CtaxEnvase	€x100
109S	Ø12mm	100	2000-5000	4,55
109T	Ø12mm+T.4X35	50	1000-2500	6,70



Blíster

Código	Referencia	Uds x Bl.	Bl. x caja	€ x Blister
B-109	12 mm	5	15	1,2
B-109T	12 mm + Pozi 4x35	5	15	1,6

Carga de extracción: 9-15Kg pladur

TPNA TACO PLADUR AUTOTALADRANTE



Código	Referencia	Espesor a Fijar	CtaxCaja	CtaxEnvase	€x100
109A.	Auto taladrante	9 a 16	100	2000-5000	12,48
109AT	Auto taladrante + Tor.Pozi 4x35	9 a 16	50	1000-2500	16,20



Blíster

Código	Referencia	Uds x Bl.	Bl. x caja	€ x Blister
B-109A	Autotaladrante	5	15	1,2
B-109AT	Autotala. + pozi 4x35	5	15	1,6

Carga de extracción: 12-25Kg pladur

Bolsa Autoservicio



Código	Referencia	Uds x Bl.	Bl. x caja	€ x Bolsa
TNAP-B010	Autotala. + pozi 4x35	10	20	2,0
TNAP-B030	Autotala. + pozi 4x35	30	15	5.4

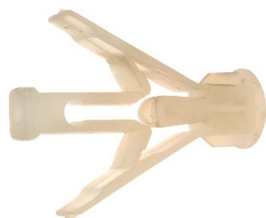

Ny
NYLON

Código	Referencia	Espesor pared	CtaxCaja	CtaxEnvase	€x100
1101040	Ø 10x40mm	4 a 12	100	900	7,06
1101047	Ø 10x47mm	15 a 19	100	900	7,66

Granel

Código	Referencia	CtaxEnvase	€x100
110G1040	Ø 10x40mm	8000	6,60
110G1047	Ø 10x47mm	7000	7,20



Código	Referencia	CtaxCaja	CtaxEnvase	€x100
110T1040	Ø 10x40 + Pozi 4.5x50	100	900	10,50
110T1041	Ø 10x47 + Pozi 4.5x60	50	450	12,20

Blíster



Código	Referencia	Uds x Bl.	Bl. x caja	€ x Blíster
11480	10x40	5	15	1,5
B110T1040	10x40 + Pozi 4,5x50	5	15	1,5
010627	10x40 +Alcayata	5	15	1,9
010634	10x47	5	15	1,9
010641	10x47 + Pozi 4,5x60	5	15	1,9

Bolsa Autoservicio



Código	Referencia	Uds x Bl.	Bl. x caja	€ x Bolsa
TAP1040-B010	10x40	10	25	1,0
TAP1040-B030	10x40	30	15	2,4
TAP1047-B010	10x47	10	25	1,0
TAP1047-B025	10x47	25	15	2,4

Carga de extracción

Pladur 12mm: 40Kg

TACO PLADUR ALAS Ø8



Código	Referencia	CtaxCaja	€x100
110C8	Ø 8x40mm	50	6,60
110E8	Ø 8x40mm+Alcayata	50	7,20
110G8	Ø 8X40mm+Gancho	50	7,20

ANJUARGO, S.L.

210 FIJACIONES PARA PLADUR METALICA



TPZ TACO PLADUR ZAMAK



Zk
ZAMAK

Código	Referencia	Espesor pared	CtdadxCaja	CtaxEnvase	€x100
210S	Ø 12 mm	9 a 16	100	2000-5000	20,00



Z
Zinc

Código	Referencia	CtdadxCaja	CtaxEnvase	€x100
210T	Ø 12 mm ZAMAK+ Tornillo 4.2X32	50	1000-2500	25,86

Carga de extracción: 12-25Kg pladur

Blister



Código	Referencia	Uds x Bl.	Bl. x caja	€ x Blister
B-210A	zamak	5	15	2,4
B-210AT	zmk + din 4,2x32	5	15	2,4

Bolsa Autoservicio



Código	Referencia	Uds x Bl.	Bl. x caja	€ x Bolsa
TMAP-B010	Ø12 zamak+Tornillo	10	20	3,0



ANJUARGO, S.L.

ANCLAJES QUIMICOS

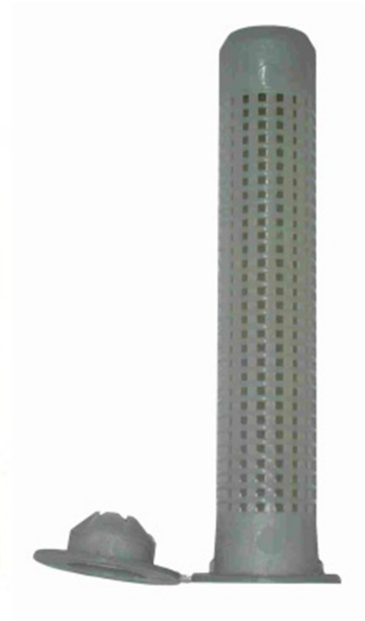

ANJUARGO, S.L.

400 CARTUCHOS DE RESINA

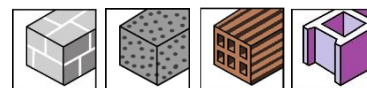

Código	Referencia	CtaxCaja	€x Uds
400P165	175 ml POLYESTER	12	12,50
400P300	300 ml POLYESTER	12	12,50
400P400	410 ml POLYESTER	12	13,50

Código	Referencia	CtaxCaja	€x Uds
KITBRIC	KIT- Taco quimico 300ml+ 4 Tamices, 4 varillas M-8 con tuerca y arandela + 2 Canulas mezcladoras	1	20

Datos de capacidad de carga para introducir la varilla

Diametro varilla	Diametro agujero	Profundidad agujero	Distancia al borde Nm	Distancia ente anclajes Nm	Mínimo espesor del hormigón	Características de carga mínima del hormigón 30Nmm2	Carga mínima recomendada del hormigon 30Nmm2
D (mm)	Do(mm)	He(mm)	B(mm)	C(mm)	A(mm)	(KN)	(KG)
8	10	80	120	80	110	12.5	420
10	12	90	135	90	120	23.1	770
12	14	110	165	110	140	23.9	900
16	18	125	190	125	165	38.9	1230
20	22	170	255	170	220	53.5	1780
24	26	210	315	210	270	66	2200

1KN=100Kg

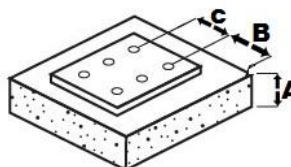

Fijación y tiempo de espera

Temperatura de aplicación (°C)	Rango de fijación (minutos)	Espera (minutos)
30	3-5	20
25	4-7	30
20	5-10	40
10	10-20	60
5	15-30	120

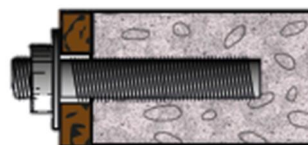

ANJUARGO, S.L.

401 ACCESORIOS TACO QUIMICO

CÁNULA MEZCLADORA



Código	Referencia	CtaxCaja	CtdaxBolsa	€x100
401M	Cánula Mezcladora-Granel	1200		39,00
401MA	Cánula mezcladora con colgador	800		54,00
401BM	Cánula Mezcladora-Bolsa	100	10	40.20

TAMIZ DE NYLON



Código	Referencia	CtaxCaja	Ctda x bolsa	€x100
401T12050	Ø 12X60mm	200	10	18
401T12080	Ø 12X80mm	100	10	20
401T15085	Ø 16X85mm	100	10	19
401T15130	Ø 16X130mm	50	10	22
401T20085	Ø 20x85mm	50	10	22

KITS DE ESPARRAGO QUIMICO



Código	Referencia	BolsaxCaja	Ctda x Bolsa	€xBolsa
401KK08	4Varilla M-8x110 + 4Áran + 4Tuerca	20	10	2,70
401KK10	4Varilla M-10x130 + 4Áran + 4Tuerca	10	5	2,95

KITS DE ESPARRAGO + TAMIZ

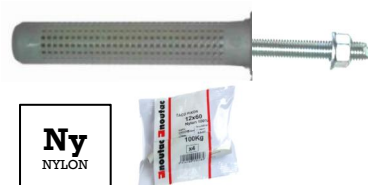

Código	Referencia	BolsaxCaja	Ctda x Bolsa	€xBolsa
KITV08	4Varillas M-8 + 4Áran + 4Tuerca + 4Tamiz 15x85	20	4	1,84
KITV10	4Varillas M-10 + 4 Áran + 4Tuerca + 4Tamiz 15x130	20	4	3,24

PISTOLA QUIMICO



Código	Referencia	CtaxCaja	€xUds
PK300	Pistola 300 ml	5	15,90

ANJUARGO, S.L.

ANCLAJES METALICOS

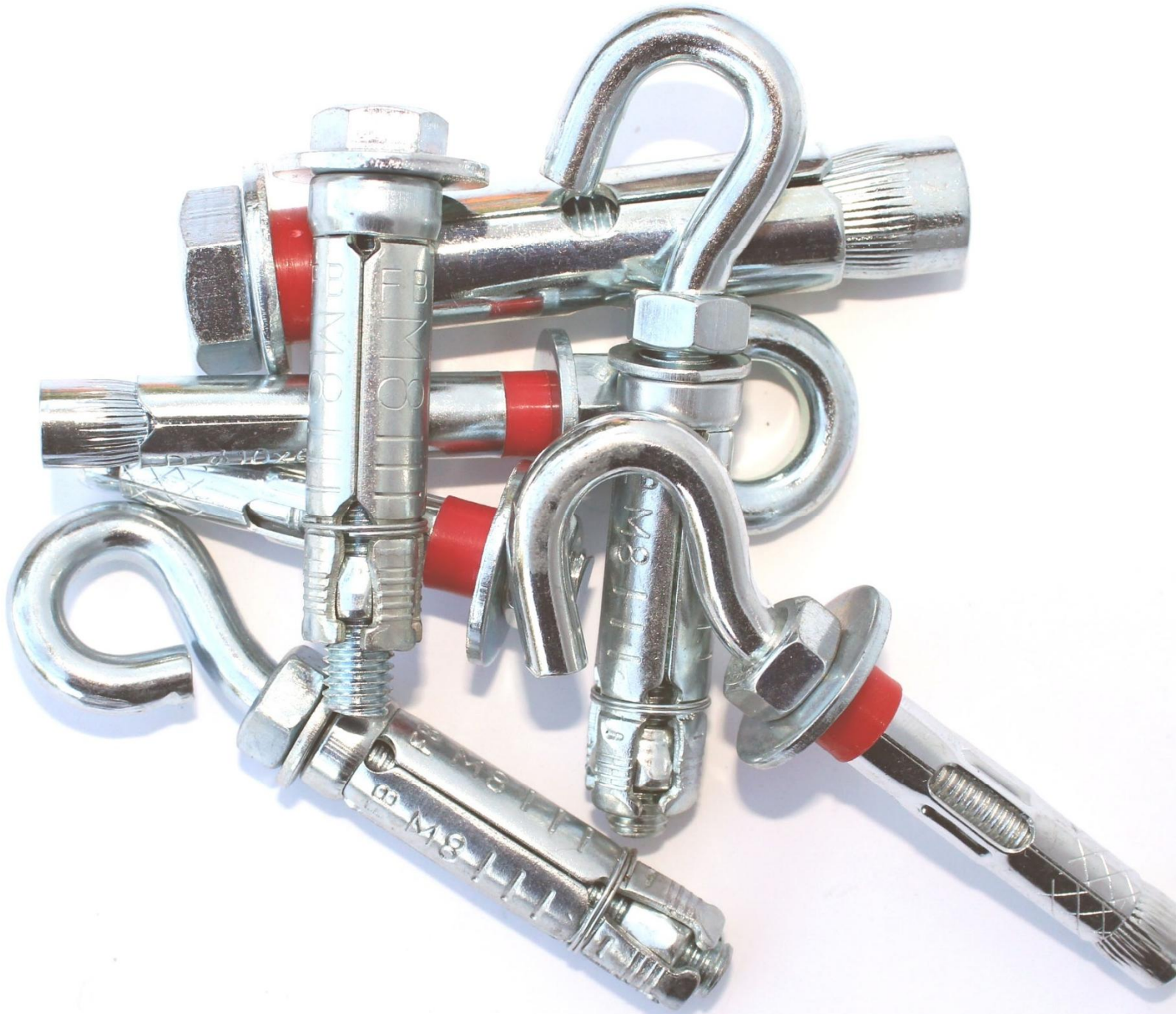

ANJUARGO, S.L.

200 ANCLAJE NT

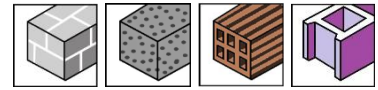

NT TORNILLO

Calidad 6.8



Z

Zinc



Código	Referencia	CtaxCaja	€/100
200T06045	M-6x45 Ø8	100	22,00
200T06060	M-6x60 Ø8	100	25,00
200T08060	M-8x60 Ø10	50	40,00
200T08080	M-8x80 Ø10	50	47,00
200T10070	M-10x70 Ø12	50	67,00
200T10100	M-10x100 Ø12	25	84,00
200T12080	M-12x80 Ø16	25	129,00
200T12100	M-12x110 Ø16	25	150,00
200T16110	M-16x110 Ø20	10	292,00
200T16130	M-16x130 Ø20	10	713,00

Caja expositora

Código	Referencia	Uds. x caja	€ x caja
11750	M- 6x45 Ø8	40	10
11751	M- 6x60 Ø8	30	10
11752	M- 8x60 Ø10	20	9
11753	M- 8x80 Ø10	10	7
11754	M- 10x70 Ø12	10	7
11755	M- 10x100 Ø12	5	5



Blíster

Código	Referencia	Uds x Bl.	Bl. x caja	€ x Blister
11706	M- 6x45 Ø8	2	15	1,4
11708	M- 6x60 Ø8	2	15	1,4
11710	M- 8x60 Ø10	2	15	1,4
11712	M- 8x80 Ø10	2	15	1,4
11714	M- 10x70 Ø12	2	15	2,5
11716	M- 10x100 Ø12	2	15	2,5
11718	M- 12x80 Ø16	1	15	2,5



Bolsa Autoservicio

Código	Referencia	Uds x Bl.	Bl. x caja	€ x Bolsa
NT08T06045-B10	M- 6x45 Ø8	10	25	2.25
NT08T06060-B10	M- 6x60 Ø8	10	20	2.55
NT10T08060-B10	M- 8x60 Ø10	10	20	4.05
NT10T08080-B06	M- 8x80 Ø10	6	20	3,00
NT12T10070-B04	M- 10x70 Ø12	4	20	3,00



ANJUARGO, S.L.

200 ANCLAJE METALICO

NT ARGOLLA



Z

Zinc



Código	Referencia	CtaxCaja	€/100
200A06045	M-6x45 Ø8	50	34,00
200A08060	M-8x60 Ø10	50	60,00
200A10070	M-10X70 Ø12	25	220,00
200A12080	M-12x80 Ø16	25	170,00

Blíster



Código	Referencia	Uds x Bl.	Bl. x caja	€ x Blíster
11746	M- 6x45 Ø8	2	15	1,5
11747	M- 8x60 Ø10	1	15	1,5

NT GANCHO



Z

Zinc



Código	Referencia	CtaxCaja	€/100
200G06045	M-6x45 Ø8	50	34,00
200G08060	M-8x60 Ø10	50	60,00
200G10070	M-10X70 Ø12	25	220,00
200G12080	M-12X80 Ø16	25	170,00

Blíster



Código	Referencia	Uds x Bl.	Bl. x caja	€ x Blíster
11736	M- 6x45 Ø8	2	15	1,5
11738	M- 8x60 Ø10	1	15	1,5

NT ESPARRAGO



Z

Zinc



Código	Referencia	CtaxCaja	€/100
200E06045	M-6x45 Ø8	100	30,00
200E08060	M-8x60 Ø10	50	49,00
200E08080	M-8x80 Ø10	50	60,00
200E10070	M-10X70 Ø12	50	75,00

Blíster



Código	Referencia	Uds x Bl.	Bl. x caja	€ x Blíster
11726	M- 6x45 Ø8	2	15	1,5
11728	M- 8x60 Ø10	2	15	2,5
11730	M- 8x80 Ø10	2	15	2,5
11731	M- 10x70 Ø12	2	15	2,5

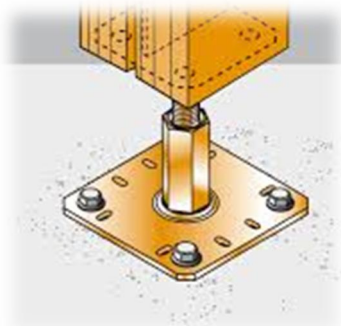

ANJUARGO, S.L.

201 ANCLAJE HEMBRA ACERO

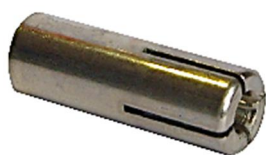
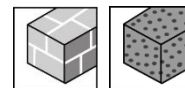

Z

Zinc

Código	Referencia	Taladro	CtaxCaja	€/100
20106AHM	M 6x25mm	Ø8	100	11,00
20108AHM	M 8x30mm	Ø10	100	15,00
20110AHM	M 10x40mm	Ø12	50	25,00
20112AHM	M 12x50mm	Ø15	50	63,10
20116AHM	M 16x60mm	Ø20	25	163,55

202 ANCLAJE HEMBRA LATON

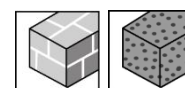

Lt

Latón

Código	Referencia	Taladro	CtaxCaja	€/100
20204	M 4X16mm	Ø5	500	10,84
20205	M 5X18mm	Ø6	300	20,74
20206	M 6X23mm	Ø8	200	26,21
20208	M 8X28mm	Ø10	100	46,49
20210	M 10X34mm	Ø12	130	67,22
20212	M 12X38mm	Ø15	70	147,92

203 ANCLAJE MACHO

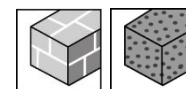

Z

Zinc



Código	Referencia	CtaxCaja	€/100
20306045	Ø 6x45mm	100	28,62
20306060	Ø 6x60mm	100	28,84
20306070	Ø 6x70mm	10	24,00
20308050	Ø 8x50mm	50	35,00
20308075	Ø 8x75mm	50	35,00
20308100	Ø 8x100mm	50	46,00
20310070	Ø 10x70mm	50	53,95
20310090	Ø 10X90 mm	50	52,00
20310100	Ø 10x100 mm	25	57,00
20312075	Ø 12X75mm	25	77,71
20312110	Ø 12X110mm	25	79,00
20316125	Ø 16x125mm	25	175,53
20316145	Ø 16x145mm	25	215,84
20320170	Ø 20x170mm	10	401,17
20320220	Ø 20x220mm	15	475,00

Blíster

Código	Referencia	Uds x Bl.	Bl. x caja	€ x Blíster
01420	M-6x70 Ø6	2	10	2.0
01475	M-8x75 Ø8	2	10	2.0
01482	M-8x100 Ø8	2	10	2.0
01536	M-10x90 Ø10	2	10	2.0
01550	M-10x100 Ø10	2	10	2.0
01604	M-12x110 Ø10	1	10	2.0

ANJUARGO, S.L.

204 ANCLAJE EXPANSION ACERO

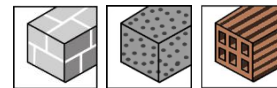

AA TORNILLO



Z
Zinc



A
Acero

Código	Referencia	CtaxCaja	€/100
204T06	M-6x50 Ø10	100	34,00
204T08	M- 8x60 Ø14	100	59,00
204T10	M-10x70 Ø16	50	78,00
204T12	M-12x100 Ø20	25	190,00



Caja expositora

Código	Referencia	Uds x Caja	€ x Blister
11520	M-6x50 Ø10	20	7,5
11521	M-8x60 Ø14	10	6,5
11522	M-10x70 Ø16	5	5,0

Blister



Código	Referencia	Uds x Bl.	Bl. x caja	€ x Blister
11850	M-6 Ø10	2	10	2,7
11851	M-8 Ø14	2	10	2,7
11852	M-10 Ø16	2	10	2,7

AA ARGOLLA



Z
Zinc



A
Acero

Código	Referencia	CtaxCaja	€/100
204A06	M-6x55 Ø10	100	67,00
204A08	M-8x60 Ø14	100	99,00
204A10	M-10x95 Ø16	50	162,00

Blister



Código	Referencia	Uds x Bl.	Bl. x caja	€ x Blister
11870	M-6 Ø10	2	10	2,0
11871	M-8 Ø14	2	10	2,0
11872	M-10 Ø16	2	10	2,0

AA GANCHO



Z
Zinc



A
Acero

Código	Referencia	CtaxCaja	€/100
204G06	M-6x55 Ø10	100	67,00
204G08	M-8x60 Ø14	100	99,00
204G10	M-10x95 Ø16	50	162,00

Blister



Código	Referencia	Uds x Bl.	Bl. x caja	€ x Blister
11880	M-6 Ø10	2	10	2,0
11881	M-8 Ø14	2	10	2,0
11882	M-10 Ø16	1	10	2,0

ANJUARGO, S.L.

FIJACIONES PARA MATERIALES HUECOS

205 ANCLAJE ARPA

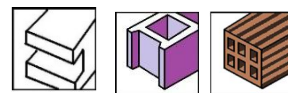

Z
Zinc



Código	Referencia	Espesor pared	CtaxCaja	€/100
205421T25	M- 4X21 Tor. 25 Ø8	1-4	100	22,22
205432T38	M- 4x32 Tor. 38 Ø8	3-9	100	20,00
205438T45	M- 4x38 Tor. 45 Ø8	8-15	100	22,00
205446T52	M- 4x46 Tor. 52 Ø8	16-21	100	24,00
205537T45	M- 5x37 Tor. 45 Ø10	5-13	100	27,00
205552T58	M- 5x52 Tor. 58 Ø10	5-16	100	31,00
205565T71	M- 5x65 Tor. 71 Ø10	16.32	100	36,00
205637T45	M- 6x37 Tor. 45 Ø12	5-13	100	31,00
205652T58	M- 6x52 Tor. 58 Ø12	5-16	100	37,00
205665T71	M- 6x65 Tor. 71 Ø12	16.32	100	56,77

Blíster



Código	Referencia	Uds x Bl.	Bl. x caja	€ x Blíster
11580	M- 4x21 T25	6	15	2.0
11581	M- 4x38 T45	6	15	2.0
11582	M- 5x52 T58	6	15	2.0
11583	M- 5x65 T71	6	15	2.0
11584	M- 6x52 T58	6	15	2.0
11585	M- 6x65 T71	6	15	2.0

Bolsa Autoservicio



Código	Referencia	Uds x Bl.	Bl. x caja	€ x Bolsa
TMA0432-B25	M- 4x32 T38	25	25	5,25
TMA0438-B20	M- 4x38 T45	20	25	4,60
TMA0445-B20	M- 4x46 T52	20	25	5,00
TMA0537-B15	M-5x37 T45	15	25	4,35
TMA0550-B15	M- 5x52 T58	15	25	4,95
TMA060-B10	M- 5x65 T71	10	15	3,80
TMA0637-B10	M- 6x37 T45	10	25	3,30
TMA0652-B08	M- 6x52 T58	8	15	3,20

UTILES DE COLOCACION



Código	Referencia	CtaxCaja	€/100
205PIN	Pinza	1	1542

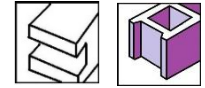

CABEZAL BALANCIN



Z

Zinc

Código	Referencia	CtaxCaja	€/100
208C06	M-6	100	45,84
208C08	M-8	50	66,30

Kit cabezal balancín M-6



Código	Referencia	Ctadxbolsa	CtaxCaja	€/100
208K06	4 M-6+4Aran+4Tuercas	4	50	280,00

BALANCIN ESPARRAGO

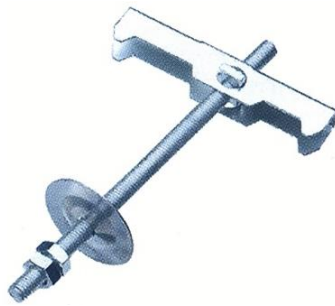

Z

Zinc

Código	Referencia	CtaxCaja	€/100
208E04	M-4 Ø12	50	46,38
208E05	M-5 Ø12	50	59,52
208E06	M-6 Ø16	25	67,62
208E08	M-8 Ø24	25	100,00

Blíster



Código	Referencia	Uds x Bl.	Bl. x caja	€ x Blister
41110	M-4	2	15	1,6
41112	M-5	2	15	1,6
41115	M-6	2	15	1,9

BALANCIN GANCHO



Z

Zinc

Código	Referencia	CtaxCaja	€/100
208G04	M-4 Ø12	50	49,80
208G05	M-5 Ø12	50	60,00
208G06	M-6 Ø16	25	74,46
208G08	M-8 Ø24	25	127,00

Blíster



Código	Referencia	Uds x Bl.	Bl. x caja	€ x Blister
41111	M-4	2	15	1,6
41113	M-5	2	15	1,6
41116	M-6	2	15	1,9

BALANCIN TORNILLO



Z

Zinc

Código	Referencia	CtaxCaja	€/100
208T04	M-4 Ø12	100	42,00
208T05	M-5 Ø12	100	45,00
208T06	M-6 Ø16	50	92,00

ANJUARGO, S.L.

209 PALOMILLAS

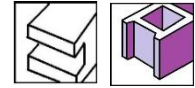

PALOMILLA ESPARRAGO



Z

Zinc

Código	Referencia	CtaxCaja	€/100
209E04	M-4 Ø12	50	49,80
209E05	M-5 Ø15	50	60,00
209E06	M-6 Ø18	50	79,20

Blister



Código	Referencia	Uds x Bl.	Bl. x caja	€ x Blister
40112	M-4	2	15	1,6
40110	M-5	2	15	1,6
40113	M-6	2	15	1,9

PALOMILLA GANCHO



Z

Zinc

Código	Referencia	CtaxCaja	€/100
209G04	M-4 Ø12	50	49,80
209G05	M-5 Ø15	50	60,00
209G06	M-6 Ø18	25	79,20

Blister



Código	Referencia	Uds x Bl.	Bl. x caja	€ x Blister
40115	M-4	2	15	1,6
40111	M-5	2	15	1,6
40114	M-6	2	15	1,9

CABEZAL PALOMILLA



Z

Zinc

Código	Referencia	CtaxCaja	€/100
209C06	M-6	200	19,00

304 MANGUITOS

MANGUITO HEXAGONAL



Z

Zinc

Código	Referencia	CtaxCaja	€/100
304H0420	M-4x20mm	100	14,00
304H0620	M-6x20mm	100	15,00
304H0630	M-6x30mm	100	20,00
304H0825	M-8x25mm	100	16,00
304H1030	M-10x30mm	50	32,00

MANGUITO REDONDO



Z

Zinc

Código	Referencia	CtaxCaja	€/100
304R0620	M-6x20mm	100	23,00
304R0630	M-6x30mm	100	25,00
304R0825	M-8x25mm	100	29,00
304R1030	M-10x30mm	50	33,00

FIJACIONES PARA TUBO

ANJUARGO, S.L.



ANJUARGO, S.L.

300 GRAPAS

GRAPA 1 PIE



Z

Zinc

Código	Referencia	CtaxCaja	€/100
300N06	Ø 6 mm	100	5,70
300N08	Ø 8 mm	100	6,02
300N10	Ø 10 mm	100	7,16
300N12	Ø 12 mm	100	7,20
300N14	Ø 14 mm	100	7,50
300N15	Ø 15 mm	100	7,62
300N16	Ø 16 mm	100	7,74
300N18	Ø 18 mm	100	11,96
300N20	Ø 20 mm	100	11,62
300N22	Ø 22 mm	100	13,50
300N24	Ø 24 mm	100	19,26
300N25	Ø 25 mm	100	17,92
300N26	Ø 26 mm	100	14,94
300N28	Ø 28 mm	100	16,98
300N30	Ø 30 mm	100	18,66
300N32	Ø 32 mm	100	20,18
300N37	Ø 37 mm	100	21,53
300N40	Ø 40 mm	50	26,46
300N42	Ø 42 mm	50	28,10
300N47	Ø 47 mm	50	31,46

Blister



Código	Referencia	Uds x Bl.	Bl x caja	€ x Blister
42073	M- 12 mm	6	15	1,2
42074	M- 14 mm	4	15	1,2
42076	M- 16 mm	4	15	1,2
42077	M- 18 mm	4	15	1,2
42078	M- 20 mm	3	15	1,2
42079	M- 22 mm	3	15	1,2
42080	M- 25 mm	3	15	1,2
42081	M- 26 mm	3	15	1,2
42082	M- 28 mm	3	15	1,2
42084	M- 32 mm	2	15	1,2

Bolsa Autoservicio



Código	Referencia	Uds x Bl.	Bl x Caja	€ x Bolsa
GN16-B010	Ø 16 mm	10	10	1,26
GN20-B010	Ø 20 mm	10	10	1,70
GN25-B008	Ø 25 mm	8	10	1,48
GN32-B006	Ø 32 mm	6	10	1,56

ANJUARGO, S.L.

300 GRAPAS

GRAPA PUENTE



Z

Zinc

Código	Referencia	CtaxCaja	€/100
300P08	Ø 8 mm	100	11,90
300P10	Ø 10 mm	100	12,10
300P12	Ø 12 mm	100	12,20
300P14	Ø 14 mm	100	13,40
300P15	Ø 15 mm	100	14,02
300P16	Ø 16 mm	100	14,64
300P18	Ø 18 mm	100	14,95
300P20	Ø 20 mm	100	22,40
300P22	Ø 22 mm	100	21,69
300P25	Ø 25 mm	100	22,50
300P26	Ø 26 mm	100	22,60
300P28	Ø 28 mm	100	24,02
300P30	Ø 30 mm	100	27,40
300P32	Ø 32 mm	100	28,40
300P37	Ø 37 mm	100	30,10
300P40	Ø 40 mm	50	32,20
300P42	Ø 42 mm	50	33,60
300P47	Ø 47 mm	50	46,20
300P50	Ø 50 mm	50	47,30
300P60	Ø 60 mm	50	66,10

Blíster



Código	Referencia	Uds x Bl.	Bl x Caja	€ x Blíster
42175	Ø 16 mm	4	15	1,2
42176	Ø 18 mm	3	15	1,2
42177	Ø 20 mm	3	15	1,2
42178	Ø 22 mm	3	15	1,2
42180	Ø 25 mm	3	15	1,2
42181	Ø 28 mm	2	15	1,2

Bolsa Autoservicio



Código	Referencia	Uds x Bl.	Bl x Caja	€ x Bolsa
GP16-B010	Ø 16 mm	10	10	1,84
GP20-B010	Ø 20 mm	10	10	1,88
GP25-B008	Ø 25 mm	8	10	1,68
GP32-B006	Ø 32 mm	6	10	1,50

ANJUARGO, S.L.

301 ABRAZADERA METALICA M-6



B

Bicro

Código	Referencia	CtaxCaja	€/100
30108	Ø 08 mm M-6	100	21,00
30110	Ø 10 mm M-6	100	21,10
30112	Ø 12 mm M-6	100	21,18
30114	Ø 14 mm M-6	100	21,42
30115	Ø 15 mm M-6	100	21,78
30116	Ø 16 mm M-6	100	22,68
30118	Ø 18 mm M-6	100	23,28
30120	Ø 20 mm M-6	100	24,06
30122	Ø 22 mm M-6	100	24,96
30124	Ø 24 mm M-6	100	25,68
30125	Ø 25 mm M-6	100	26,34
30126	Ø 26 mm M-6	100	26,34
30128	Ø 28 mm M-6	100	27,42
30132	Ø 32 mm M-6	100	31,10
30135	Ø 35 mm M-6	100	35,82
30138	Ø 38 mm M-6	50	38,52
30140	Ø 40 mm M-6	50	39,24
30142	Ø 42 mm M-6	50	39,36
30147	Ø 47 mm M-6	50	43,14
30150	Ø 50 mm M-6	50	45,36
30154	Ø 54 mm M-6	50	54,54
30160	Ø 60 mm M-6	50	59,58
30163	Ø 63 mm M-6	50	61,62
30167	Ø 67 mm M-6	50	43,97

Blister

Código	Referencia	Uds x Bl.	Bl. X Caja	€ x Blister
42540	M-6 10 mm	5	15	1,6
42523	M-6 12 mm	5	15	1,6
42524	M-6 14 mm	5	15	1,6
42525	M-6 15 mm	5	15	1,6
42526	M-6 16 mm	5	15	1,6
42527	M-6 18 mm	5	15	1,6
42528	M-6 20 mm	4	15	1,6
42529	M-6 22 mm	4	15	1,6
42530	M-6 24 mm	4	15	1,6
42531	M-6 26 mm	2	15	1,6
42532	M-6 28 mm	2	15	1,6
42533	M-6 30 mm	2	15	1,6

303 TORNILLO ABRAZADERA



B

Bicro

Código	Referencia	CtaxCaja	€/100
3036030	M-6x30 mm	200	5,16
3036040	M-6x40 mm	200	8,50
3036050	M-6x50 mm	100	10,50
3038040	M-8x40 mm	100	11,50

ANJUARGO, S.L.

302 ABRAZADERA SIN FIN

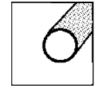

Z
Zinc

Código	Referencia	CtaxCaja	€/100
302008016	Ø 8-16 mm Banda 9 mm	100	49,92
302012020	Ø 12-22 mm Banda 9 mm	100	51,48
302016027	Ø 16-27 mm Banda 9 mm	100	53,04
302018025	Ø 18-25 mm Banda 9 mm	100	42,00
302020032	Ø 20-32 mm Banda 9 mm	50	56,16
302025040	Ø 25-40 mm Banda 9 mm	50	59,28
302032050	Ø 32-50 mm Banda 9 mm	50	62,16
302040060	Ø 40-60 mm Banda 9 mm	50	67,08
302050070	Ø 50-70 mm Banda 9 mm	50	73,32
302060080	Ø 60-80 mm Banda 9 mm	50	76,44
302070090	Ø 70-90 mm Banda 9 mm	25	79,56
302080100	Ø 80-100 mm Banda 9 mm	25	88,92
302090110	Ø 90-110 Banda 9 mm	25	96,90
302100120	Ø 100-120 mm Banda 9 mm	25	101,40
302110130	Ø 110-130 mm Banda 9 mm	25	106,08
302120140	Ø 120-140 mm Banda 9 mm	25	110,76
302130150	Ø 130-150 mm Banda 9 mm	25	136,00
302BT1315	Ø 13-15 Butano	100	34,00
302BT1518	Ø 15-17 Butano	100	35,00

Blíster



Código	Referencia	Uds x Bl.	Bl x Caja	€ x Blister
43149	A. Butano 15-17	3	15	1.9
43150	M- 9 mm / 8-16	3	15	2,4
43151	M- 9 mm / 12-20	3	15	2,4
43152	M- 9 mm / 16-27	3	15	2,4
43153	M- 9 mm / 20-32	3	15	2,4
43155	M- 9 mm / 25-40	3	15	2,4
43157	M- 9mm / 32-50	3	15	2.7
43158	M- 9mm / 40-60	3	15	2.7

308 GRAPA DE PLASTICO



Ny
NYLON

Código	Referencia	CtaxCaja	€/100
308C15	Ø 15-16 mm	100	32,00
308C20	Ø 20-22 mm	100	42,00
308C25	Ø 25 mm	100	52,00
308C32	Ø 32mm	100	70,00

317 CINTA PERFORADA



Z
Zinc

Código	Referencia	CtaxCaja	€/100
3170810	17x0.8/ 10 Mtrs.	10	870,00

ANJUARGO, S.L.

TORNILLERIA



ANJUARGO, S.L.

500 TORNILLO POZIDRIV DIN -5705A

B

Bicro

Z

Zinc



Código	Código	Referencia	CtaxCaja	€/100
500B25012	500Z25012	Ø 2,5x12 mm	1000	1,08
500B25016	500Z25016	Ø 2,5x16 mm	1000	1,14
500B25020	500Z25020	Ø 2,5x20 mm	1000	1,33
500B30012	500Z30012	Ø 3x12 mm	1000	0,85
500B30016	500Z30016	Ø 3x16 mm	1000	0,99
500B30020	500Z30020	Ø 3x20 mm	1000	1,10
500B30025	500Z30025	Ø 3x25 mm	1000	1,24
500B30030	500Z30030	Ø 3x30 mm	1000	1,42
500B30035	500Z30035	Ø 3x35 mm	1000	2,08
500B30040	500Z30040	Ø 3x40 mm	1000	1,89
500B30045	500Z30045	Ø 3x45 mm	1000	2,83
500B30050	500Z30050	Ø 3x50 mm	1000	3,35
500B35012	500Z35012	Ø 3,5x12 mm	1000	1,35
500B35016	500Z35016	Ø 3,5x16 mm	1000	1,16
500B35020	500Z35020	Ø 3,5x20 mm	1000	1,35
500B35025	500Z35025	Ø 3,5x25 mm	1000	1,53
500B35030	500Z35030	Ø 3,5x30 mm	1000	1,71
500B35035	500Z35035	Ø 3,5x35 mm	500	2,05
500B35040	500Z35040	Ø 3,5x40 mm	500	2,21
500B35045	500Z35045	Ø 3,5x45 mm	500	3,32
500B35050	500Z35050	Ø 3,5x50 mm	250	2,80
500B40016	500Z40016	Ø 4x16 mm	1000	1,42
500B40020	500Z40020	Ø 4x20 mm	1000	1,68
500B40025	500Z40025	Ø 4x25 mm	1000	1,92
500B40030	500Z40030	Ø 4x30 mm	500	2,25
500B40035	500Z40035	Ø 4x35 mm	500	2,40
500B40040	500Z40040	Ø 4x40 mm	500	2,66
500B40045	500Z40045	Ø 4x45 mm	500	3,05
500B40050	500Z40050	Ø 4x50 mm	250	3,30
500B40055	500Z40055	Ø 4x55 mm	250	5,21
500B40060	500Z40060	Ø 4x60 mm	100	4,08
500B40070	500Z40070	Ø 4x70 mm	100	4,93
500B45016	500Z45016	Ø 4,5x16 mm	500	2,32
500B45020	500Z45020	Ø 4,5x20 mm	500	2,14
500B45025	500Z45025	Ø 4,5x25 mm	500	2,53
500B45030	500Z45030	Ø 4,5x30 mm	500	2,73
500B45035	500Z45035	Ø 4,5x35 mm	500	3,11
500B45040	500Z45040	Ø 4,5x40 mm	250	3,49
500B45045	500Z45045	Ø 4,5x45 mm	500	3,87
500B45050	500Z45050	Ø 4,5x50 mm	250	4,13
500B45055	500Z45055	Ø 4,5x55 mm	250	6,72
500B45060	500Z45060	Ø 4,5x60 mm	250	5,20
500B45070	500Z45070	Ø 4,5x70 mm	250	6,36
500B50016	500Z50016	Ø 5x16 mm	500	3,45
500B50020	500Z50020	Ø 5x20 mm	500	2,67
500B50025	500Z50025	Ø 5x25 mm	500	3,18
500B50030	500Z50030	Ø 5x30 mm	250	3,40
500B50035	500Z50035	Ø 5x35 mm	250	4,03
500B50040	500Z50040	Ø 5x40 mm	250	4,30
500B50045	500Z50045	Ø 5x45 mm	250	5,20
500B50050	500Z50050	Ø 5x50 mm	250	5,40
500B50055	500Z50055	Ø 5x55 mm	250	6,53
500B50060	500Z50060	Ø 5x60 mm	250	6,17

B

Bicro

Z

Zinc



Código	Código	Referencia	CtaxCaja	€/100
500B50070	500Z50070	Ø 5x70 mm	100	7,33
500B50080	500Z50080	Ø 5x80 mm	100	8,56
500B50090	500Z50090	Ø 5x90 mm	100	10,54
500B50100	500Z50100	Ø 5x100 mm	100	12,07
500B60040	500Z60040	Ø 6x40 mm	250	6,55
500B60045	500Z60045	Ø 6x45 mm	250	8,69
500B60050	500Z60050	Ø 6x50 mm	250	7,59
500B60055	500Z60055	Ø 6x55 mm	100	10,89
500B60060	500Z60060	Ø 6x60 mm	100	9,08
500B60070	500Z60070	Ø 6x70 mm	100	11,37
500B60080	500Z60080	Ø 6x80 mm	100	12,33
500B60090	500Z60090	Ø 6x90 mm	100	14,92
500B60100	500Z60100	Ø 6x100 mm	100	16,15
500B60110	500Z60110	Ø 6x110 mm	100	20,68
500B60120	500Z60120	Ø 6x120 mm	100	25,15
500B60130	500Z60130	Ø 6x130 mm	100	26,74
500B60140	500Z60140	Ø 6x140 mm	100	28,94
500B60150	500Z60150	Ø 6x150 mm	100	30,63

Blister

Código	Referencia	Uds x Bl.	Bl x Caja	€ x Blister
927147	Ø 3x20	30	15	1,2
927154	Ø 3x30	25	15	1,2
927161	Ø 3x40	20	15	1,2
927178	Ø 3,5x20	25	15	1,2
927185	Ø 3,5x30	20	15	1,2
927192	Ø 3,5x40	20	15	1,2
927215	Ø 3,5x50	15	15	1,2
927222	Ø 4x20	20	15	1,2
927239	Ø 4x30	20	15	1,2
927277	Ø 4,5X20	20	15	1,2
927284	Ø 4,5X25	20	15	1,2
927291	Ø 4,5X30	20	15	1,2
927301	Ø 4,5X35	15	15	1,2
927314	Ø 4,5X40	15	15	1,2
927321	Ø 4,5X45	10	15	1,2
927338	Ø 4,5X50	10	15	1,2
927345	Ø4,5X60	8	15	1,2
927352	Ø 4,5X70	8	15	1,2
927369	Ø 5X20	15	15	1,2
927376	Ø 5X25	15	15	1,2
927383	Ø 5X30	10	15	1,2
927390	Ø 5X35	10	15	1,2
927406	Ø 5X40	10	15	1,2
927413	Ø 5X45	10	15	1,2
927420	Ø 5X50	8	15	1,2
927437	Ø 5X60	8	15	1,2
927475	Ø 6X40	5	15	1,2
927482	Ø6X50	5	15	1,2

ANJUAGO, S.L.

500 TORNILLO POZIDRIV INOX A2

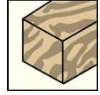

A2

Inox



A2

Inox



Código	Referencia	CtaxCaja	€/100
500I30012	Ø 3x12 mm	1000	2,43
500I30016	Ø 3x16 mm	1000	2,80
500I30020	Ø 3x20 mm	1000	3,15
500I30025	Ø 3x25 mm	1000	3,50
500I30030	Ø 3x30 mm	1000	3,86
500I30035	Ø 3x35 mm	1000	4,48
500I30040	Ø 3x40 mm	1000	4,94
500I30045	Ø 3x45 mm	1000	5,72
500I30050	Ø 3x50 mm	1000	6,20
500I35012	Ø 3,5x12 mm	1000	3,86
500I35016	Ø 3,5x16 mm	1000	3,16
500I35020	Ø 3,5x20 mm	1000	3,51
500I35025	Ø 3,5x25 mm	1000	4,10
500I35030	Ø 3,5x30 mm	1000	4,60
500I35035	Ø 3,5x35 mm	500	5,40
500I35040	Ø 3,5x40 mm	500	5,97
500I35045	Ø 3,5x45 mm	500	6,56
500I35050	Ø 3,5x50 mm	250	7,10
500I40016	Ø 4x16 mm	1000	4,05
500I40020	Ø 4x20 mm	1000	4,45
500I40025	Ø 4x25 mm	1000	5,16
500I40030	Ø 4x30 mm	500	5,99
500I40035	Ø 4x35 mm	500	6,67
500I40040	Ø 4x40 mm	500	7,34
500I40045	Ø 4x45 mm	500	8,02
500I40050	Ø 4x50 mm	250	8,80
500I40060	Ø 4x60 mm	100	10,58
500I45016	Ø 4,5x16 mm	250	5,34
500I45020	Ø 4,5x20 mm	500	5,91
500I45025	Ø 4,5x25 mm	500	6,64
500I45030	Ø 4,5x30 mm	500	7,45
500I45035	Ø 4,5x35 mm	500	8,42
500I45040	Ø 4,5x40 mm	250	9,12
500I45045	Ø 4,5x45 mm	500	9,99
500I45050	Ø 4,5x50 mm	500	10,70

Código	Referencia	CtaxCaja	€/100
500I50020	Ø 5x20 mm	500	7,21
500I50025	Ø 5x25 mm	500	8,21
500I50030	Ø 5x30 mm	500	9,26
500I50035	Ø 5x35 mm	500	10,26
500I50040	Ø 5x40 mm	250	11,39
500I50045	Ø 5x45 mm	250	12,39
500I50050	Ø 5x50 mm	200	13,36
500I50060	Ø 5x60 mm	200	15,66
500I50070	Ø 5x70 mm	200	18,28
500I50080	Ø 5x80 mm	200	21,43
500I50090	Ø 5x90 mm	200	21,32
500I50100	Ø 5x100 mm	100	32,86
500I60040	Ø 6x40 mm	100	17,87
500I60045	Ø 6x45 mm	100	19,36
500I60050	Ø 6x50 mm	100	20,92
500I60060	Ø 6x60 mm	250	24,57
500I60070	Ø 6x70 mm	250	29,67
500I60080	Ø 6x80 mm	250	34,94
500I60090	Ø 6x90 mm	100	37,58
500I60100	Ø 6x100 mm	100	44,85
500I60110	Ø 6x110 mm	50	57,94

ANJUARGO, S.L.

113 TAPON ADHESIVO Ø13



Código	Referencia	CtaxCaja	€/100
113B	Ø 13 Blanco	1000	3,55
113M	Ø 13 Marrón	1000	3,55
113H	Ø 13 Haya	1000	3,55



Código	Referencia	Uds x Bl.	Bl x Caja	€ x Blister
TEPB-B20	Color Blanco Ø13	20	15	2,4
TEPM-B20	Color Marrón Ø13	20	15	2,4
TEPH-B20	Color Haya Ø13	20	15	2,4

113 TAPON EMBELLECEDOR



Código	Código	Código	Código	Ref.	Ctax Caja	€/100
11303B	11303N	11303M	11303A	Ø 3 mm	1000	2,98
11304B	11304N	11304M	11304A	Ø 4 mm	1000	2,98
11305B	11305N	11305M	11305A	Ø 5 mm	1000	3,46
11306B	11306N	11306M	11306A	Ø 6 mm	1000	3,46
11308B	11308N	11308M	11308A	Ø 8 mm	1000	3,46
11309B	11309N	11309M	11309A	Ø 9 mm	1000	3,46
11310B	11310N	11310M	11310A	Ø10mm	1000	3,46
113PB	113PN	113PM	113PA	PHILIPS	1000	2,98

ANJUARGO, S.L.

502 TORNILLO BARRAQUERO DIN 571

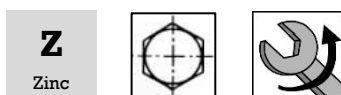

Código	Referencia	CtdadxCaja	€/100
502Z06030	Ø 6x30 mm	200	4,90
502Z06035	Ø 6x35 mm	200	5,50
502Z06040	Ø 6x40 mm	200	5,70
502Z06045	Ø 6x45 mm	200	6,10
502Z06050	Ø 6x50 mm	200	6,60
502Z06060	Ø 6x60 mm	200	7,80
502Z06070	Ø 6x70 mm	200	8,60
502Z06075	Ø 6x75 mm	200	9,50
502Z06080	Ø 6x80 mm	200	10,40
502Z07030	Ø 7x30 mm	200	8,50
502Z07035	Ø 7x35 mm	200	8,80
502Z07040	Ø 7x40 mm	200	9,10
502Z07045	Ø 7x45 mm	200	9,40
502Z07050	Ø 7x50 mm	200	9,80
502Z07060	Ø 7x60 mm	100	11,10
502Z07070	Ø 7x70 mm	100	12,80
502Z07080	Ø 7x80 mm	100	14,40
502Z07090	Ø 7x90 mm	100	16,60
502Z07100	Ø 7x100 mm	100	18,50
502Z07110	Ø 7x110 mm	100	19,70
502Z07120	Ø 7x120 mm	100	20,80
502Z07130	Ø 7x130 mm	100	22,50
502Z07140	Ø 7x140 mm	100	24,10
502Z07150	Ø 7x150 mm	100	25,10
502Z08030	Ø 8x30 mm	200	10,70
502Z08035	Ø 8x35 mm	200	10,90
502Z08040	Ø 8x40 mm	200	11,30
502Z08045	Ø 8x45 mm	200	11,90
502Z08050	Ø 8x50 mm	200	12,70
502Z08060	Ø 8x60 mm	200	14,50
502Z08070	Ø 8x70 mm	200	16,50
502Z08080	Ø 8x80 mm	200	18,70
502Z08090	Ø 8x90 mm	100	21,90

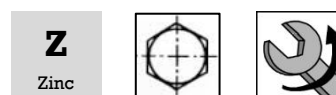

Código	Referencia	CtdadxCaja	€/100
502Z08100	Ø 8x100 mm	100	23,90
502Z08110	Ø 8x110 mm	100	25,80
502Z08120	Ø 8x120 mm	100	27,70
502Z08130	Ø 8x130 mm	100	32,10
502Z08140	Ø 8x140 mm	100	33,90
502Z08150	Ø 8x150 mm	100	35,90
502Z08160	Ø 8x160 mm	100	38,10
502Z08170	Ø 8x170 mm	100	40,10
502Z08180	Ø 8x180mm	100	47,60
502Z08190	Ø 8x190 mm	100	50,10
502Z08200	Ø 8x200 mm	100	52,30
502Z10050	Ø 10x50 mm	100	24,60
502Z10060	Ø 10x60 mm	100	28,20
502Z10070	Ø 10x70 mm	100	32,10
502Z10080	Ø 10x80 mm	100	36,10
502Z10090	Ø 10x90 mm	100	37,90
502Z10100	Ø 10x100 mm	100	44,50
502Z10110	Ø 10x110 mm	100	46,60
502Z10120	Ø 10x120 mm	50	52,40
502Z10130	Ø 10x130 mm	50	58,70
502Z10140	Ø 10x140 mm	50	64,90
502Z10150	Ø 10x150 mm	50	71,20
502Z10160	Ø 10x160 mm	50	78,30
502Z10170	Ø 10x170 mm	50	87,99
502Z10180	Ø 10x180 mm	50	86,10
502Z10190	Ø 10x190 mm	50	90,80
502Z10200	Ø 10x200 mm	50	95,50

[Consulte disponibilidad en INOX](#)

ANJUARGO, S.L.

542 ARANDELA DIN 125



Z

Zinc

Código	Referencia	CtaxCaja	€/100
542Z03	M-3	1000	0,50
542Z04	M-4	1000	0,54
542Z05	M-5	1000	0,73
542Z06	M-6	500	1,16
542Z08	M-8	250	1,67
542Z10	M-10	250	3,48
542Z12	M-12	250	6,02
542Z14	M-14	250	9,15
542Z16	M-16	100	10,64
542Z18	M-18	100	14,42
542Z20	M-20	50	16,12
542Z22	M-22	50	18,12
542Z24	M-24	25	31,24

[Consulte disponibilidad en INOX](#)

541 ARANDELA DIN 9021

ARANDELA ZINCADA



Z

Zinc

Código	Referencia	CtaxCaja	€/100
541Z03	M-3	1000	0,75
541Z04	M-4	1000	1,30
541Z05	M-5	1000	1,80
541Z06	M-6	500	2,38
541Z08	M-8	250	5,88
541Z10	M-10	250	10,78
541Z12	M-12	250	19,90
541Z14	M-14	250	31,80
541Z16	M-16	100	37,65
541Z18	M-18	100	71,25
541Z20	M-20	50	81,28
541Z22	M-22	50	154,80
541Z24	M-24	25	163,00

504 ARANDELA VULCANIZADA EPDM



Z

Zinc

Código	Referencia	CtaxCaja	€/100
504G14	Ø 14 mm	1000	3,37
504G16	Ø 16 mm	1000	3,64
504G19	Ø 19 mm	1000	4,45
504G25	Ø 25 mm	500	7,30

[Consulte disponibilidad en INOX](#)

ANJUARGO, S.L.

510 TORNILLO AUTOTALADRANTE DIN 7504-K



DIN 7504k SIN ARANDELA

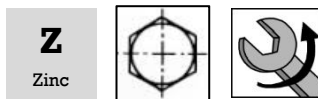

Código	Referencia	CtaxCaja	€/100
510S35013	Ø 3.5x13 mm	1000	2,59
510S35016	Ø 3.5x16 mm	1000	2,73
510S35019	Ø 3,5x19 mm	1000	2,94
510S35022	Ø 3,5x22 mm	1000	3,16
510S35025	Ø 3.5x25 mm	1000	3,38
510S35032	Ø 3.5x32 mm	500	4,13
510S42013	Ø 4.2x13 mm	1000	2,97
510S42016	Ø 4.2x16 mm	1000	3,21
510S42019	Ø 4.2x19 mm	1000	3,51
510S42022	Ø 4.2x22 mm	1000	3,73
510S42025	Ø 4.2x25 mm	500	3,94
510S42032	Ø 4.2x32 mm	500	4,62
510S42038	Ø 4.2x38 mm	500	4,91
510S42050	Ø 4.2x50 mm	500	5,97
510S48013	Ø 4.8x13 mm	1000	3,43
510S48016	Ø 4.8x16 mm	1000	3,78
510S48019	Ø 4.8x19 mm	500	4,10
510S48022	Ø 4.8x22 mm	500	4,35
510S48025	Ø 4.8x25 mm	500	4,59
510S48032	Ø 4.8x32 mm	500	5,81
510S48038	Ø 4.8x38 mm	500	6,62
510S48050	Ø 4.8x50 mm	500	7,88
510S48063	Ø 4.8x63 mm	500	9,80
510S55019	Ø 5.5x19 mm	500	5,40
510S55022	Ø 5.5x22 mm	500	5,81
510S55025	Ø 5.5x25 mm	500	6,13
510S55032	Ø 5.5X32 mm	500	7,21
510S55038	Ø 5.5X38 mm	500	7,91
510S55050	Ø 5.5x50 mm	500	9,64
510S55063	Ø 5.5x63 mm	250	11,50
510S63019	Ø 6.3x19 mm	500	8,07
510S63022	Ø 6.3x22 mm	500	8,61
510S63025	Ø 6.3x25 mm	500	9,13
510S63032	Ø 6.3x32 mm	500	10,40
510S63038	Ø 6.3x38 mm	500	11,50
510S63050	Ø 6.3x50 mm	250	14,04
510S63063	Ø 6.3x63 mm	250	16,82
510S63075	Ø 6.3x75 mm	250	18,90
510S63090	Ø 6.3x90 mm	250	25,57
510S63100	Ø 6.3x100 mm	100	28,57
510S63115	Ø 6.3x115 mm	100	36,94
510S63125	Ø 6.3x125 mm	100	41,63
510S63130	Ø 6.3x130 mm	100	42,28
510S63140	Ø 6.3x140 mm	100	52,30
510S63150	Ø 6.3x150 mm	100	58,05

ANJUARGO, S.L.

510 TORNILLO AUTOTALADRANTE DIN 7504-K



DIN 7504K CON EPDM 16

Código	Referencia	CtaxCaja	€/100
510A48016	Ø 4.8x16 EPDM 16	1000	8,07
510A48019	Ø 4.8x19 EPDM 16	1000	8,37
510A48022	Ø 4.8x22 EPDM 16	1000	8,72
510A48025	Ø 4.8x25 EPDM 16	500	9,05
510A48032	Ø 4.8X32 EPDM 16	500	9,88
510A48038	Ø 4.8x38 EPDM 16	500	10,75
510A48050	Ø 4.8x50 EPDM 16	500	12,20

Z

Zinc

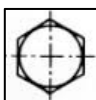

DIN 7504K CON EPDM 19

Código	Referencia	CtaxCaja	€/100
510A55022-19	Ø 5.5x22 EPDM 19	500	11,07
510A55025-19	Ø 5.5x25 EPDM 19	500	12,42
510A55032-19	Ø 5.5x32 EPDM 19	500	12,58
510A55038-19	Ø 5.5x38 EPDM 19	500	13,45
510A55050-19	Ø 5.5x50 EPDM 19	500	15,66
510A55063-19	Ø 5.5x63 EPDM 19	250	17,79
510A63019-19	Ø 6.3x19 EPDM 19	500	13,55
510A63022-19	Ø 6.3x22 EPDM 19	500	14,20
510A63025-19	Ø 6.3x25 EPDM 19	500	13,68
510A63032-19	Ø 6.3x32 EPDM 19	500	15,12
510A63038-19	Ø 6.3x38 EPDM 19	500	16,58
510A63050-19	Ø 6.3x50 EPDM 19	250	18,85
510A63063-19	Ø 6.3x63 EPDM 19	250	21,62
510A63075-19	Ø 6.3x75 EPDM 19	250	25,80
510A63090-19	Ø 6.3x90 EPDM 19	250	32,67
510A63100-19	Ø 6.3x100 EPDM 19	100	35,87
510A63115-19	Ø 6.3x115 EPDM 19	100	45,40
510A63125-19	Ø 6.3x125 EPDM 19	100	49,89
510A63130-19	Ø 6.3x130 EPDM 19	100	55,48
510A63140-19	Ø 6.3x140 EPDM 19	100	61,99
510A63150-19	Ø 6.3x150 EPDM 19	100	68,22

DIN 7504K CON EPDM 25

Código	Referencia	CtaxCaja	€/100
510A55022-25	Ø 5.5x22 EPDM 25	500	15,74
510A55025-25	Ø 5.5x25 EPDM 25	500	16,12
510A55032-25	Ø 5.5x32 EPDM 25	500	17,41
510A55038-25	Ø 5.5x38 EPDM 25	500	18,30
510A55050-25	Ø 5.5x50 EPDM 25	500	20,65
510A55063-25	Ø 5.5x63 EPDM 25	250	23,06
510A63019-25	Ø 6.3x19 EPDM 25	500	18,47
510A63022-25	Ø 6.3x22 EPDM 25	500	19,14
510A63025-25	Ø 6.3x25 EPDM 25	500	19,66
510A63032-25	Ø 6.3x32 EPDM 25	500	21,35
510A63038-25	Ø 6.3x38 EPDM 25	500	23,08
510A63050-25	Ø 6.3x50 EPDM 25	250	23,68
510A63063-25	Ø 6.3x63 EPDM 25	250	26,62
510A63075-25	Ø 6.3x75 EPDM 25	250	31,53
510A63090-25	Ø 6.3x90 EPDM 25	250	37,34
510A63100-25	Ø 6.3x100 EPDM-25	100	40,98
510A63115-25	Ø 6.3x115 EPDM-25	100	48,19
510A63125-25	Ø 6.3x125 EPDM-25	100	53,91
510A63130-25	Ø 6.3x130 EPDM-25	100	57,80
510A63140-25	Ø 6.3x140 EPDM-25	100	65,07
510A63150-25	Ø 6.3x150 EPDM-25	100	72,71

Blíster



Código	Referencia	Uds x Bl.	Bl x Caja	€ x Blíster
040006	4,8X16 EPDM 16	5	15	1,2
040013	4,8X19 EPDM 16	5	15	1,2
040020	4,8X25 EPDM 16	4	15	1,2
040037	4,8X32 EDPM 16	4	15	1,2
040044	4,8X38 EPDM 16	4	15	1,2
040051	5,5X22 EPDM 19	4	15	1,2
040068	5,5X25 EDPM 19	4	15	1,2
040075	5,5X32 EPDM 19	4	15	1,2
040082	5,5X38 EPDM 19	2	15	1,2
040099	5,5X50 EPDM 19	2	15	1,2
040105	5,5X63 EPDM 19	2	15	1,2

ANJUARGO, S.L.

531 GANCHO, ARGOLLAS Y ALCAYATAS

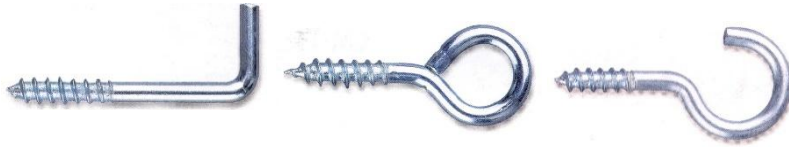
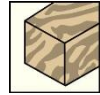

Z

Zinc

Código	Código	Código	Referencia	CtaxCaja	€/100
531E14025	531A14025	531G14025	M- 14x25 d.2.6x17	500	3,29
531E16030	531A16030	531G16030	M- 16x30 d. 3.1x20	300	3,74
531E17040	531A17040	531G17040	M- 17x40 d. 3.5x29	300	5,24
531E18040	531A18040	531G18040	M- 18x40 d. 4.1x28	300	6,00
531E18050	531A18050	531G18050	M- 18x50 d.4.1x37	300	6,58
531E19050	531A19050	531G19050	M- 19x50 d. 4.4x37	200	8,46
531E19060	531A19060	531G19060	M- 19x60 d.4.4x46	200	9,14
531E19070	531A19070	531G19070	M- 19x70 d.4.4x55	200	10,40
	531A20050	531G20050	M- 20x50 d.5.0x40	200	9,65
531E20060	531A20060	531G20060	M- 20x60 d. 5.0x44	200	11,22
531E20070	531A20070	531G20070	M- 20x70 d.5.0x53	200	12,12
531E20080	531A20080	531G20080	M- 20x80 d.5.0x63	200	13,69
	531A21070	531G21070	M- 21x70 d. 5.0x53	200	15,19
531E21080	531A21080	531G21080	M- 21x80 d. 5.1x60	200	16,84
531E21090	531A21090	531G21090	M- 21x90 d. 5.6x70	200	18,11
531E21100	531A21100	531G21100	M- 21x100 d.6.0x79	100	20,14

Blíster

ARGOLLA	GANCHO	ALCAYATA	Referencia	Uds x Bl.	Bl x Caja	€ x Blister
011747	011587	012133	M- 14x25 d.2.6x17	20	15	1,5
011754	011594	012140	M- 16x30 d. 3.1x20	18	15	1,5
011761	011600	011464	M- 17x40 d. 3.5x29	12	15	1,5
011785	011624	011488	M- 18x50 d. 4.1x28	10	15	1,5
011808	011648	011501	M- 19x60 d.4.4x46	8	15	1,5
011846	011686	011532	M- 21x80 d. 5.0x53	6	15	1,5
011877	011713	011556	M- 21x80 d. 5.1x60	4	15	1,5

534 TUERCAS EXAGONALES

DIN 934



Z

Zinc

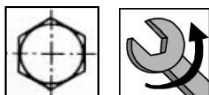

Código	Referencia	CtaxCaja	€/100
534Z03	M-3	1000	0,44
534Z04	M-4	1000	0,72
534Z05	M-5	500	0,90
534Z06	M-6	500	1,30
534Z08	M-8	250	2,70
534Z10	M-10	250	5,90
534Z12	M-12	250	8,90
534Z14	M-14	250	12,80
534Z16	M-16	100	16,90
534Z18	M-18	100	24,98
534Z20	M-20	50	32,50
534Z22	M-22	50	43,90
534Z24	M-24	25	62,10

ANJUARGO, S.L.

535 PUNTAS DE ACERO

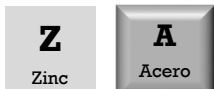
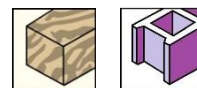

Código	Referencia	CtaxCaja	€/100
53522520	Ø 2.25 x 20 mm	500	1,70
53522525	Ø 2.25 x 25 mm	500	1,97
53522530	Ø 2.25 x 30 mm	500	1,98
53525040	Ø 2.5 x 40 mm	500	3,40
53525050	Ø 2.5 x 50 mm	500	4,80
53529060	Ø 2.9 x 60 mm	300	6,16

Blister

Código	Referencia	Uds x Bl.	Bl x Caja	€ x Blister
02950	Ø 2.25x20	50	15	1,5
02967	Ø 2.25x25	40	15	1,5
02974	Ø 2.25x30	30	15	1,5
02981	Ø 2.5x40	25	15	1,5
02998	Ø 2.5x50	18	15	1,5
03001	Ø 2.9x60	12	15	1,5

532 REMACHE ALUMINIO DIN 7337



Código	Referencia	CtaxCaja	€ x 100
532A3006	M-3X6	500	1.68
532A3008	M-3X8	500	1.78
532A3010	M-3X10	500	1.92
532A3012	M-3X12	500	2.10
532A3016	M-3X16	500	2.62
532A3018	M-3X18	500	2.75
532A4006	M-4X6	500	2.27
532A4008	M-4X8	500	2.30
532A4010	M-4X10	500	2.51
532A4012	M-4X12	500	2.65
532A4014	M-4X14	500	2.98
532A4016	M-4X16	500	3.19
532A4018	M-4X18	500	3.37
532A5008	M-5X8	500	3.37
532A5010	M-5X10	500	3.65
532A5012	M-5X12	500	3.78
532A5014	M-5X14	250	4.35
532A5016	M-5X16	250	4.54
532A5018	M-5X18	250	4.78
53A25020	M-5X20	250	5.59

Blister

Código	Referencia	Uds x Bl.	Bl x Caja	€ x Blister
011907	M-3X6	20	15	1,5
011914	M-3X8	20	15	1,5
011921	M-3X10	15	15	1,5
011938	M-3X12	15	15	1,5
011945	M-3X16	10	15	1,5
011952	M-3X18	10	15	1,5
011969	M-4X6	10	15	1,5
011976	M-4X8	10	15	1,5
011983	M-4X10	10	15	1,5
011990	M-4X12	10	15	1,5
012003	M-4X14	10	15	1,5
012010	M-4X16	10	15	1,5
012027	M-4X18	8	15	1,5
012034	M-5X8	8	15	1,5
012041	M-5X10	8	15	1,5
012058	M-5X12	8	15	1,5
012065	M-5X14	8	15	1,5
012072	M-5X16	6	15	1,5
012089	M-5X18	6	15	1,5
012096	M-5X20	6	15	1,5

FIJACIONES PLASTICO

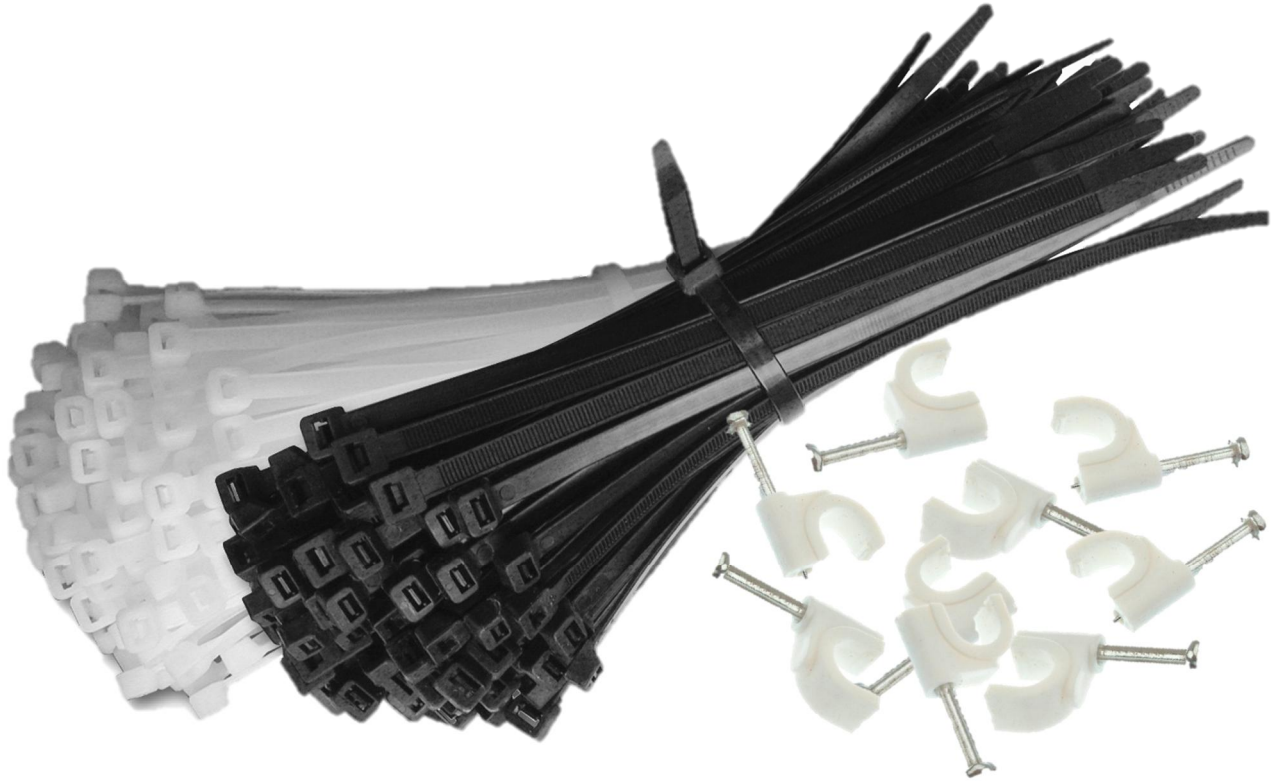

ANJUARGO, S.L.

ANJUARGO, S.L.

112 BRIDAS



N
Negro

B
Blanco

Código	Código	Referencia	CtdaxBolsa	€/100
112N25080	112B25080	M- 2,5x80 mm	100	0,99
112N25100	112B25100	M- 2,5x100 mm	100	0,90
112N25140	112B25140	M- 2,5x140 mm	100	1,90
112N25160	112B25160	M- 2,5x160 mm	100	2,00
112N25200	112B25200	M- 2,5x200 mm	100	2,10
112N36140	112B36140	M- 3,6x140 mm	100	2,40
112N36200	112B36200	M- 3,6x200 mm	100	3,10
112N36300	112B36300	M- 3,6X290 mm	100	4,90
112N36370	112B36370	M- 3,6x370 mm	100	7,70
112N48160	112B48160	M- 4,8x160 mm	100	4,80
112N48180	112B48180	M- 4,8x178 mm	100	4,30
112N48200	112B48200	M- 4,8x200 mm	100	4,60
112N48250	112B48250	M- 4,8x250 mm	100	6,60
112N48300	112B48300	M- 4,8X290 mm	100	6,50
112N48360	112B48360	M- 4,8x360 mm	100	8,05
112N48370	112B48370	M- 4,8X370 mm	100	7,90
112N48430	112B48430	M- 4,8x430 mm	100	14,15
112N76200	112B76200	M- 7,6x200 mm	100	9,80
112N76250	112B76250	M-7,6X250 mm	100	13,70
112N76300	112B76300	M- 7,6x300 mm	100	14,50
112N76370	112B76370	M- 7,6x360 mm	100	17,10
112N76430	112B76430	M- 7,6x430 mm	100	26,55
112N76530	112B76530	M- 7,6x530 mm	100	33,78
112N76540	112B76540	M- 7,6x540 mm	100	33,10
112N78750	112B78750	M- 7,8x750 mm	100	44,60

113 TACO BRIDA

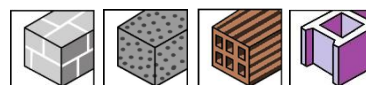

Ny
NYLON



N
Negro

Código	Referencia	CtdaxBolsa	€/100
113TB06	Ø 6mm	50	5,00
113TB08	Ø 8mm	50	5,10

ANJUARGO, S.L.

111 GRAPILLAS PARA CABLE

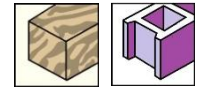

Z Zinc	A Acero	PEBD POLIETILENO
------------------	-------------------	----------------------------



Código	Referencia	Medida	CtdadxCaja	€/100
111000	Nº 00 Plano	2x0.4 - 0.7 ó 1	100	5,66
111001	Nº 01 Plano	2x0.7	100	5,49
111002	Nº 02 Plano	2x0.4 - 0.7 ó 1	100	6,16
111003	Nº 03 Plano	2x1 - 3x0.7	100	6,42
111010	Nº 1 Plano	2x1	100	7,59
111020	Nº 2 Plano	2x1.5 - 3x1	100	7,75
111030	Nº 3 Plano	3x1.5 - 3x2.5	100	9,25
111040	Nº 4 Redondo	1x1 - 2x0.5	100	2,29
111050	Nº 5 Redondo	2x0.75	100	2,49
111060	Nº 6 Redondo	2x1	100	2,52
111070	Nº 7 Redondo	2x1 - 1x1.5	100	3,00
111080	Nº 8 Redondo	2x2.5	100	3,41
111090	Nº 9 Redondo	3x2.5	100	3,67
111100	Nº 10 Redondo	2x4	100	3,72
111120	Nº 12 Redondo	3x6	100	5,25
111140	Nº 14 Redondo	4x6	100	6,83
111170	Nº 17 Redondo	3x10	100	8,67
111TV	TV Coaxial	Ø75	100	3,57

Blíster

Código	Referencia	Uds x Bl	Bl x Caja	€ x Blíster
33107	REDONDO-4	20	15	1,2
33108	REDONDO-5	20	15	1,2
33109	REDONDO-6	20	15	1,2
33110	REDONDO-7	20	15	1,2
33111	REDONDO-8	20	15	1,2
33112	REDONDO-9	10	15	1,2
33113	REDONDO-10	10	15	1,2
33114	REDONDO-12	10	15	1,2
33115	REDONDO-14	5	15	1,2
33117	TV	10	15	1,2

Blíster

Código	Referencia	Uds x Bl	Bl x Caja	€ x Blíster
33100	PLANO-0	10	15	1,2
33101	PLANO-02	10	15	1,2
33102	PLANO-01	10	15	1,2
33103	PLANO-03	10	15	1,2
33104	PLANO-1	8	15	1,2
33105	PLANO-2	8	15	1,2
33106	PLANO-3	6	15	1,2

ACCESORIOS DE MUEBLES

ANJUARGO, S.L.

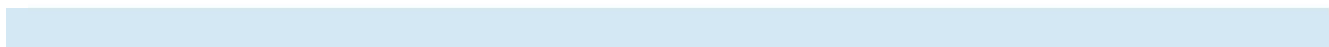

ANJUARGO, S.L.

601 SOPORTE DE VITRINA

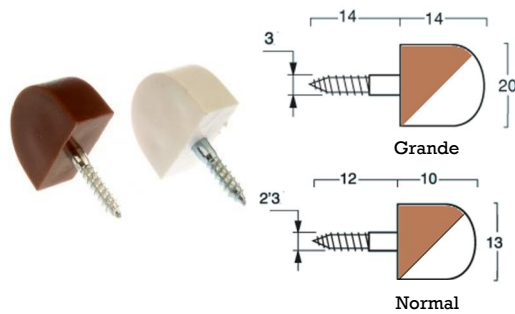
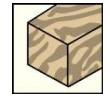

B
Blanco

M
Marrón

Código	Código	Referencia	CtdadxCaja	€/100
601GB	601GM	M- 20	1000	9,00
601NB	601NM	M- 15	1000	5,70

Blíster

Código	Referencia	Uds x bl	Bl x Caja	€ x Blíster
21100	Pequeño-Bl	16	15	1.6
21101	Pequeño-Mr	16	15	1.6
21106	Grande-Bl	8	15	1.6
21107	Grande-Mrr	8	15	1.6

602 TOPE DE 1 PUNTA

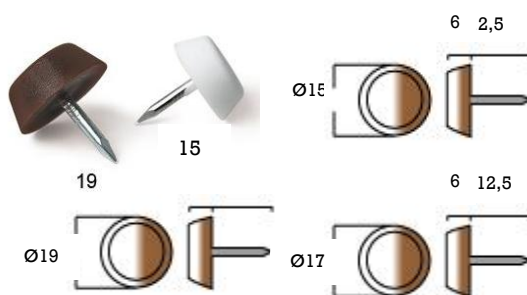

B
Blanco

M
Marrón

Código	Código	Referencia	CtaxCaja	€/100
60215B	60215M	Ø 15 mm	1000	3.50
60217B	60217M	Ø 17 mm	1000	4.80
60219B	60219M	Ø 19 mm	1000	6.60

Blíster

Código	Referencia	Uds x bl	Bl x Caja	Bl x Caja
21310	Ø15mm Blanco	14	15	1.6
21311	Ø15mm Marrón	14	15	1.6
21312	Ø17mm Blanco	12	15	1.6
21313	Ø17mm Marrón	12	15	1.6

603 TOPES DE 2 PUNTAS

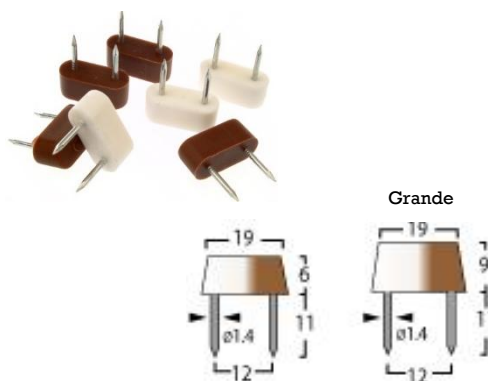

B
Blanco

M
Marrón

Código	Código	Referencia	CtaxCaja	€/100
603GB	603GM	9 mm	1000	6,60
603NB	603NM	6 mm	1000	6,60

Blíster

Código	Referencia	Uds x Bl	Bl x Caja	€ x Blíster
21120	Pequeño Bl.	14	15	1.6
21121	Pequeño mrr	14	15	1.6
21122	Grande Bl.	12	15	1.6
21123	Grande Mrr	12	15	1.6

ANJUARGO, S.L.

605 TOPE N°0 CON PUNTA



B
Blanco

M
Marrón

Código	Código	Referencia	CtaxCaja	€/100
605B	605M	Ø 16 mm	1000	5,50

Blíster

Código	Referencia	Uds x bl	Bl x Caja	€x Blíster
21212	Blanco	16	15	1.6
21213	Marrón	16	15	1.6

609 SOPORTE SAFETY

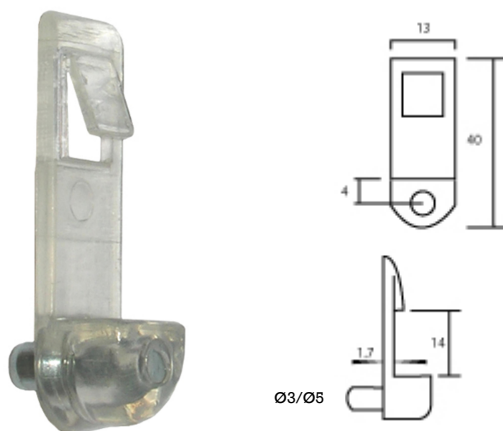

C
Cristal

Código	Referencia	CtaxCaja	€/100
60903	Ø 3 mm	1000	16,32
60905	Ø 5 mm	1000	16,32

Blíster

Código	Referencia	Uds x bl	Bl x Caja	€x Blíster
21175	Ø 5mm	4	15	1,2
21176	Ø 3mm	4	15	1,2

608 PORTAESTANTE LUNA

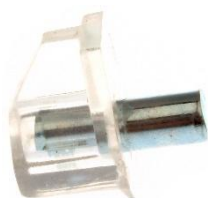

C
Cristal

B
Blanco

M
Marrón

N
Negro

Código	Código	Código	Código	Referencia	CtaxCaja	€/100
608C	608B	608M	608N	Ø 5 mm	1000	7,00

Blíster

Código	Referencia	Uds x bl	Bl x Caja	€x Blíster
20140	Blanco 5mm	10	15	1.2
20141	Marron 5mm	10	15	1.2
20142	Negro 5 mm	10	15	1.2
20143	Cristal 5 mm	10	15	1.2

ANJUARGO, S.L.

610 SOPORTE BARRA

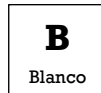

Código	Código	Código	Referencia	CtaxCaja	€/100
610B	610M	610N	M-20 mm	1000	12,24

Blíster



Código	Referencia	Uds x Bl	Bl x Caja	€ x Blister
22800	Blanco	4	15	1,2
22801	Marrón	4	15	1,2

615 SOPORTE CIRCULAR

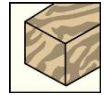

Código	Código	Referencia	CtaxCaja	€/100
615C	615O	Ø 14 mm	500	75,00

Blíster



Código	Referencia	Uds x Bl	Bl x Caja	€ x Blister
21150	Oro	8	15	7,8
21151	Cromo	8	15	7,8

616 SOPORTE JUNTA TORICA

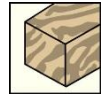

Código	Código	Referencia	CtaxCaja	€/100
616C	616O	Ø 5 mm	500	117,0

Blíster



Código	Referencia	Uds x Bl	Bl x Caja	€ x Blister
21160	Oro	8	15	5,4
21161	Cromo	8	15	5,4

617 TOPE N°1 METAL



Código	Código	Código	Referencia	CtaxCaja	€/100
617C	617O	617N	Ø 5 mm	1000	5,50

Blíster



Código	Referencia	Uds x Bl	Bl x Caja	€ x Blister
21224	Oro	10	15	1,2
21225	Cromo	10	15	1,2
21226	Negro	10	15	1,2

ANJUARGO, S.L.

618 SOPORTE ROSCA + CASQUILLO



M-8

C
Cromo

O
Oro

L
Latón

Código	Código	Referencia	CtaxCaja	€/100
618C	618O	M-6/M-8	500	190,00

Blíster

Código	Referencia	Uds x Bl	Bl x Caja	€ x Blíster
21180	Oro	4	15	12
21181	Cromo	4	15	12

622 PATA REGULADORA



Z
Zinc

Código	Referencia	CtaxCaja	€/100
6220630	M-6x20 Base Ø 30	50	81,90
6220830	M-8x20 Base Ø 30	50	63,00
6220840	M-8x20 Base Ø 40	50	77,70
6221030	M-10x30 Base Ø 30	50	69,30
6221040	M-10x30 Base Ø 40	50	84,00
622104070	M-10x70 Base Ø 40	50	105,00

EMBELLECEDOR PATA



C
Cromo

PVC

Código	Referencia	CtaxCaja	€/100
62230	Ø 30 mm	50	58,80
62240	Ø 40 mm	50	64,70

Blíster

Código	Referencia	Uds x Bl	Bl x Caja	€ x Blíster
22940	Pata M10+Embellec. 30 Cr	2	10	4,3
22941	Pata M10+Embellec. 40 Cr	2	10	4,3

ANJUARGO, S.L.

626 TOPE DE METAL

A
Avellana

G
Gris

B
Blanco

M
Marrón

N
Negro



Código	Código	Código	Código	Código	Referencia	CtaxCaja	€/100
626A	626G	626B	626M	626N	M-20 mm	100	100,00

632 TACHUELAS DE HIERRO

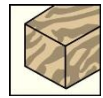

N
Níquel

L
Latón

B
Bronce



Código	Código	Código	Referencia	CtaxCaja	€/100
63208N	63208L	63208B	Ø 8 mm	1000	3,52
63209N	63209L	63209B	Ø 9 mm	1000	3,62
63210N	63210L	63210B	Ø 10 mm	1000	3,98
63212N	63212L	63212B	Ø 12 mm	1000	5,28

634 CORCHETES DE CORTINA



PE
PEHD

Código	Referencia	CtdaxBolsa	€/100
634P	PLASTICO	100	1,50

Blíster



Código	Referencia	Uds x Bl	Bl x Caja	€ x Blíster
21600	Plástico	20	15	1,2

ANJUARGO, S.L.

635 LLAVERO PORTAETIQUETAS



COLORES:



Código	Referencia	CtdaxBolsa	€/100
635	LLAVERO	100	18,30

Blíster



Código	Referencia	Uds x Bl	Bl x Caja	€ x Blíster
21735	Llavero Porta etiquetas	3	15	1,2

636 RASCAVIDRIOS



COLORES:



Código	Referencia	CtdaxBolsa	€/100
636	RASCAVIDRIO	100	108

Blíster



Código	Referencia	Uds x Bl	Bl x Caja	€ x Blíster
21750	Rasca vidrios -Colores	1	15	2

637 SUJETAMANTEL



BL

Blanco

Código	Referencia	CtdaxBolsa	€/100
637	SUJETAMANTEL BLANCO	100	20,34

Blíster



Código	Referencia	Uds x Bl	Bl x Caja	€ x Blíster
21740	Sujeta manteles blanco	4	15	1,2